

POD KEYS 2018



KEYLINE

Innovators by design | Since 1770

A BIANCHI 1770 GROUP COMPANY



THE ART OF
DUPLICATION



POD KEYS 2018



INDEX / INDICE

Pod Keys 2018

p	VI	Key cutting machines / Duplicatrici
	IX	884 Decryptor Mini
	XI	Bluetooth & Power Adaptor
	XII	884 Decryptor Ultegra
	XIV	Keyline new generation pod keys (insert cap) / Keyline pod keys di nuova generazione (con tappo a inserimento)
	XV	Keyline new generation pod keys (shell type) / Keyline pod keys di nuova generazione (con guscio)
	XVI	Keyline old generation pod keys / Keyline pod keys di vecchia generazione
	XVII	Keyline universal pod keys + dedicated pod keys fitting carbon chip format / Pod keys Keyline universali + pod keys Keyline compatibili con transponder in ceramica
	XVIII	Keyline Micro Series / Keyline Serie Micro
	XIX	Legend / Legenda
	XX	Transponder models for pod keys / Modelli transponder per pod keys
p	1	New generation pod keys / Pod keys di nuova generazione
	13	New generation pod keys - Index / Pod keys di nuova generazione - Indice
	41	Old generation pod keys / Pod keys di vecchia generazione
	49	Old generation pod keys - Index / Pod keys di vecchia generazione - Indice

Technology has found its way to beauty. Step by step, Research and Development have led us to a new concept, which we named *The Art of Duplication* and which summarises our determination to consider each and every tool as an object that can express the full talent of its user. And that can improve their world. Making it easier, more effective, more beautiful.

This is true for **Pod Keys 2018**, the new catalogue of shell and recess keys. These keys can be fitted with glass and ceramic chips of the Micro Series. For automotive professionals, Pod Keys are a convenient and versatile choice within the context of the Keyline transponder technology integrated system. A wide ranging, extremely reliable cloning system.

Pod Keys 2018 is part of the Keyline evolution towards a smarter world. A corporate history that dates back to 1770 and that has been growing day by day to improve the work of professional locksmiths and key cutters in all sectors.

Massimo Bianchi, Keyline Strategic Planner

La tecnologia ha trovato la strada per la bellezza. La ricerca e lo sviluppo, passo dopo passo, ci hanno portati a una nuova concezione: l'abbiamo chiamata *Arte della Duplicazione* e sintetizza il nostro impegno nel fare di ogni strumento un oggetto in grado di esprimere tutto il talento di chi lo userà. E di rendere migliore il suo mondo. Più semplice, più efficace, più bello.

Così è per **Pod Keys 2018**, il nuovo catalogo delle chiavi vuote con guscio e cassetto. Sono predisposte per l'inserimento dei chip in vetro e ceramica della Serie Micro. Per lo specialista auto, le Pod Keys sono una scelta vantaggiosa e versatile, all'interno del sistema integrato della tecnologia transponder Keyline. Un sistema ad ampio raggio per clonazioni al massimo dell'affidabilità.

Pod Keys 2018 è parte dell'evoluzione Keyline per un mondo più smart. Una storia nata nel 1770 e cresciuta ogni giorno migliorando in ogni ambito il lavoro degli specialisti.

Massimo Bianchi, Keyline Strategic Planner

NINJA TOTAL

For edge cut, laser and dimple keys / Per chiavi piatte, laser e punzonate



- ALL-IN ONE SOLUTION, WITH A DOUBLE CUTTING STATION
- HIGH-SPEED KEY CUTTING
- NEW C30 CLAMP
- INDUSTRIAL CONSOLE WITH THE KEYLINE LIGER SOFTWARE
- HEAD ENGRAVING FUNCTION
- PATENTED AND RELIABLE TECHNOLOGY



- SOLUZIONE ALL-IN ONE, CON DOPPIA STAZIONE DI TAGLIO
- ALTA VELOCITÀ NEL TAGLIO CHIAVI
- NUOVO MORSETTO C30
- CONSOLE INDUSTRIALE CON SOFTWARE LIGER KEYLINE
- FUNZIONE GRAVATURA TESTE
- TECNOLOGIA AFFIDABILE E BREVETTATA



Door keys



Car keys



Ford and Jaguar
Ford e Jaguar

NINJA LASER

For edge cut and laser keys / Per chiavi piatte e laser



▪ ELECTRONIC AND AUTOMATIC

▪ COMPACT DESIGN

▪ INTERACTIVE INTERFACE

▪ UNLIMITED DATABASE WITH ON BOARD CROSS REFERENCE

▪ DOUBLE CUTTER FOR EDGE CUT AND LASER KEYS



▪ ELETTRONICA E AUTOMATICA

▪ DESIGN COMPATTO

▪ INTERFACCIA INTERATTIVA

▪ DATABASE ILLIMITATO CON COMPARATIVO A BORDO

▪ DOPPIA FRESA PER CHIAVI PIATTE E LASER



Door keys



Car keys



Ford and Jaguar
Ford e Jaguar

994 LASER

For edge cut and laser automotive keys / Per chiavi piatte e laser automotive



- ERGONOMIC DESIGN
- PRECISION MECHANICS
- INTERACTIVE INTERFACE
- STABILIZED CUTTING SPEED
- UNLIMITED DATABASE WITH ON BOARD CROSS REFERENCE
- 8 CLAMPS FOR ALL AUTOMOTIVE KEYS



- DESIGN ERGONOMICO
- MECCANICA DI PRECISIONE
- INTERFACCIA INTERATTIVA
- VELOCITÀ DI TAGLIO STABILIZZATA
- DATABASE ILLIMITATO CON COMPARATIVO A BORDO
- 8 MORSETTI PER TUTTE LE CHIAVI AUTOMOTIVE



Car keys



Ford and Jaguar
Ford e Jaguar

884 DECRYPTOR MINI

For electronic keys, remote controls and keyless systems /
Per chiavi elettroniche, telecomandi e sistemi keyless



- MAXIMUM CALCULATION POWER
- MINIMUM FOOTPRINT
- LIMITLESS CONNECTIVITY
- AFFORDABLE PRICE



- MASSIMA POTENZA DI CALCOLO
- MINIMO INGOMBRO
- CONNETTIVITÀ SENZA LIMITI
- PREZZO EASY

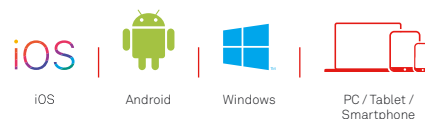

Car key cloning made easy, with extreme calculation power and an unparalleled low price.

884 Decryptor Mini is simple to use: just connect it to your Android smartphone or tablet with USB-OTG capability or to a PC Windows (7 and subsequent versions) with an Internet connection, download the **Keyline Cloning Tool mobile App*** from Google Play Store or the PC Software from the website www.keyline.it or www.keyline-usa.com and start the transponder-equipped car key automatic cloning procedure, without having to press any buttons and also without connecting to a power outlet.

Its extremely high calculation power, maximum flexibility and ease of use make it the ideal choice for professionals in the key business.

884 Decryptor Mini can be equipped with Bluetooth & Power Adaptor, the next-generation rechargeable battery with Bluetooth technology to use 884 Decryptor Mini wirelessly. With Bluetooth & Power Adaptor, 884 Decryptor Mini can be managed from any Windows PC, smartphone and tablet, Android and iOS**, thus offering an unlimited cloning service.

La clonazione di chiavi auto con una maneggevolezza unica per una potenza di calcolo estrema e un prezzo senza paragoni.

884 Decryptor Mini è semplice da usare: basta collegarla al proprio smartphone o tablet dotato di sistema operativo Android provvisto di funzionalità USB-OTG oppure al PC Windows (7 e successivi) connesso a Internet, scaricare la **App Keyline Cloning Tool*** da Google Play Store o il Software per PC dal sito www.keyline.it o www.keyline-usa.com, e avviare la procedura di clonazione in automatico di chiavi auto con transponder, senza premere nemmeno un pulsante e senza collegarsi alla presa elettrica. La sua estrema potenza di calcolo, la massima versatilità e semplicità d'uso la rendono la scelta ideale a portata di tutti i professionisti del key business.

884 Decryptor Mini può essere dotata di Bluetooth & Power Adaptor, la batteria ricaricabile di ultima generazione con tecnologia Bluetooth per utilizzare il dispositivo in modalità wireless, senza l'ausilio dei cavi di connessione. Con Bluetooth & Power Adaptor, 884 Decryptor Mini può essere gestita da qualsiasi PC Windows, smartphone e tablet, sia Android che iOS**, offrendo così un servizio di clonazione illimitato.

884 Decryptor Mini requires always internet connection.

* Keyline Cloning Tool mobile App must be used only with 884 Decryptor Mini.

** The iOS version is available exclusively with the use of Bluetooth & Power Adaptor.

884 Decryptor Mini richiede sempre la connessione internet.

* La App Keyline Cloning Tool è da utilizzarsi esclusivamente con 884 Decryptor Mini.

** La versione per iOS è disponibile esclusivamente con l'utilizzo della batteria Keyline Bluetooth & Power Adaptor.



Transponder cloning:

- Texas® fixed code
- Texas® Crypto
- Texas® 80-bit (for Kia®, Hyundai®, Ford®, Toyota®)
- Philips® fixed code
- First generation Philips® Crypto*
- Second generation Philips® Crypto
- Megamos® fixed code
- Megamos® Crypto** (to be activated with TKM. Xtreme Kit)
- Megamos® Crypto (for Kia®, Chevrolet® - Daewoo®, Pontiac®)
- Keyline Keyless Kit
- Keyline RFD100

Clonazione transponder:

- Texas® codice fisso
- Texas® Crypto
- Texas® 80-bit (per Kia®, Hyundai®, Ford®, Toyota®)
- Philips® codice fisso
- Philips® Crypto di prima generazione*
- Philips® Crypto di seconda generazione
- Megamos® codice fisso
- Megamos® Crypto** (da attivare con TKM. Xtreme Kit)
- Megamos® Crypto (per Kia®, Chevrolet® - Daewoo®, Pontiac®)
- Keyline Keyless Kit
- Keyline RFD100

TECHNICAL FEATURES

Power Supply	5V
External Connections	USB
Absorption	500mA
Connectivity	USB
Dimensions	Width: 120 mm / Depth: 100 mm / Height: 90 mm
Weight	200 gr

CARATTERISTICHE TECNICHE

Alimentazione	5V
Connessioni Esterne	USB
Assorbimento	500mA
Connettività	USB
Dimensioni	Larghezza: 120 mm / Profondità: 100 mm / Altezza: 90 mm
Peso	200 gr

All the brands and trade marks mentioned here are the exclusive property of the respective car manufacturers or groups.
 * Regarding first generation Philips® Crypto transponder, 884 Decryptor Mini can clone some PH1A; but not PH1D and also Keyline RK50 remote controls.
 ** In order to clone TKM/GKM-supported Megamos® Crypto transponders, the 884 Decryptor Mini must be activated through the TKM. Xtreme Kit. For a complete list of models that can be cloned to date, please consult the TKM. Xtreme Kit page. To get information on prices, please contact your area sales agent or the nearest distributor.

Tutti i marchi e i marchi di fabbrica qui pubblicati sono marchi registrati e di esclusiva proprietà delle rispettive case o gruppi automobilistici.
 * Circa i transponder Philips® Crypto di prima generazione 884 Decryptor Mini è in grado di clonare alcuni transponder PH1A; non sono clonabili transponder PH1D e i radiocomandi Keyline RK50.
 ** Per effettuare la clonazione dei transponder Megamos® Crypto supportati da TKM e GKM, 884 Decryptor Mini deve essere attivata tramite TKM. Xtreme Kit. Per consultare la lista completa di modelli ad ora clonabili si veda la pagina di TKM. Xtreme Kit. Per essere informati sui prezzi, si prega di rivolgersi direttamente al proprio agente di zona o al distributore più vicino.

BLUETOOTH & POWER ADAPTOR

For 884 Decryptor Mini / Per 884 Decryptor Mini



- STABLE AND LONG-LASTING CHARGE
- WIRELESS CLONING SERVICE
- IMMEDIATELY USABLE WITH THE KEYLINE CLONING TOOL APP FOR IOS AND ANDROID
- CHARGING VIA PC CONNECTION OR THROUGH BATTERY CHARGER
- CARICA STABILE E DI LUNGA DURATA
- SERVIZIO DI CLONAZIONE WIRELESS
- UTILIZZO IMMEDIATO CON LA APP KEYLINE CLONING TOOL PER IOS E ANDROID
- RICARICA TRAMITE CONNESSIONE A PC O TRAMITE CARICA BATTERIA DA RETE

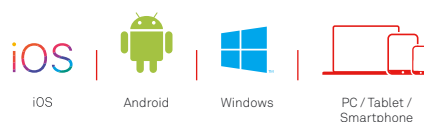

Keyline **Bluetooth & Power Adaptor** is the next-generation rechargeable battery with Bluetooth technology to use 884 Decryptor Mini wirelessly, without the aid of connecting cables. With Bluetooth & Power Adaptor, 884 Decryptor Mini can be managed from any smartphone and tablet*, Android and iOS.

Bluetooth & Power Adaptor di Keyline è la batteria ricaricabile di ultima generazione con tecnologia Bluetooth per utilizzare 884 Decryptor Mini in modalità wireless, senza l'ausilio dei cavi di connessione.

Con Bluetooth & Power Adaptor, 884 Decryptor Mini può essere gestita da qualsiasi PC Windows, smartphone e tablet*, sia Android che iOS.

* 884 Decryptor Mini with Bluetooth & Power Adaptor can also be used with PC (Windows).

* 884 Decryptor Mini con Bluetooth & Power Adaptor può essere utilizzata anche con PC (Windows).



884 DECRYPTOR ULTEGRA

For electronic keys, remote controls and keyless systems /
Per chiavi elettroniche, telecomandi e sistemi keyless



- INTUITIVE MULTI-LANGUAGE GRAPHIC DISPLAY
- DISPLAY GRAFICO INTUITIVO E MULTILINGUA
- VIRTUALLY UNLIMITED POSSIBILITIES OF EXPANSION
- POSSIBILITÀ DI ESPANSIONE VIRTUALMENTE ILLIMITATE
- EXTREMELY FAST DUPLICATION
- ESTREMA VELOCITÀ DI DUPLICAZIONE

The **884 Decryptor Ultegra** device is Keyline's solution for the cloning of electronic keys and remote controls.

Its advanced computing power, ease of use and versatility guaranteed by easy and quick updates, make this the ideal choice for specialists in the automotive technology sector.

Il dispositivo **884 Decryptor Ultegra** è la soluzione Keyline per la clonazione delle chiavi elettroniche e telecomandi.

La sua estrema potenza di calcolo, unita alla grande semplicità d'uso e alla versatilità garantita da una facile e veloce procedura di aggiornamento, la rendono la scelta ideale per lo specialista nel campo dell'automotive technology.

* All the brands and trade marks mentioned here are the exclusive property of the respective car manufacturers or groups.
** In order to clone Texas® 80-bit transponders, the 884 Decryptor Ultegra requires internet connection.
*** In order to clone TKM/GKM-supported Megamos® Crypto transponders the 884 Decryptor Ultegra requires internet connection and must be activated through the TKM Xtreme Kit.

* Tutti i marchi e i marchi di fabbrica qui pubblicati sono marchi registrati e di esclusiva proprietà delle rispettive case o gruppi automobilistici.
** Per effettuare la clonazione dei transponder Texas® 80-bit, 884 Decryptor Ultegra deve essere connessa a internet.
*** Per effettuare la clonazione dei transponder Megamos® Crypto supportati da TKM e GKM, 884 Decryptor Ultegra deve essere attivata tramite TKM Xtreme Kit e connessa a internet.



Transponder cloning*

- Stand-alone cloning for Philips® Crypto 1st Generation transponders.
- Cloning in stand alone mode for fixed code transponders.
- Stand-alone cloning for Texas® Crypto transponders using Keyline TK100 electronic heads, GK100 glass chips or CK100 carbon chips.
- Cloning of a part of the Texas® 80-bit** transponders using TK100 electronic heads or CKG carbon chips.
- Stand-alone cloning for Philips® Crypto 1st Generation transponders ID45 VAG-Ford, ID 4W Peugeot, ID42 Volkswagen and Seat.
- Stand-alone cloning for Philips® Crypto 2nd Generation transponder using TK100, GK100 or CK100.
- Cloning for Megamos® Crypto*** transponders using TKM electronic heads or GKM glass chips.
- Programming of fixed code transponder through the manual entry of ID.
- Automatic generation of some codes for fixed code transponder.
- Stand-alone cloning for Megamos® Crypto transponders for Kya, Chevrolet-Daewoo and Pontiac.

Remote control cloning

- Built-in radio frequency station for cloning Philips® Crypto 2nd generation remote control through the RK60, the new Keyline electronic head equipped with remote control. The RK60 is fully compatible with all Keyline horseshoe blades that are used with Philips® Crypto 2nd generation equipped vehicles.
- RFD100 and RFD80 models for Ford remote keys. Clonable with the 884 Decryptor Ultegra (RFD100) or entirely on-board programmable (RFD80), they guarantee perfect synchronization with the original Ford remote without altering the functionality.

Other functions

- Multi-functional alphanumeric keypad.
- RS232 & USB connection.
- Graphical display.
- Self antenna for all transponder types.
- 12V cigarette lighter adaptor for use directly in the vehicle.

TECHNICAL FEATURES

Power Supply	DC 12V; power adapter included
External Connections	RS232 and USB serial ports
Absorption	20W
Dimensions	Width: 220 mm / Depth: 130 mm / Height: 70 mm
Weight	1 Kg

Clonazione transponder*

- Clonazione di transponder Philips® Crypto di prima generazione.
- Clonazione di tutti i tipi di transponder a codice fisso.
- Clonazione di transponder Texas® Crypto tramite il TK100, il GK100 o il CK100.
- Clonazione di parte dei transponder Texas® 80-bit** tramite TK100 o CKG.
- Clonazione di transponder Philips® Crypto di prima generazione ID45 VAG-Ford, ID 4W Peugeot, ID42 Volkswagen e Seat.
- Clonazione di transponder Philips® Crypto di seconda generazione tramite il TK100, il GK100 o il CK100.
- Clonazione di transponder Megamos® Crypto*** tramite il TKM o il GKM.
- Programmazione transponder a codice fisso tramite inserimento manuale ID.
- Generazione automatica di alcuni codici per transponder a codice fisso.
- Clonazione di transponder Megamos® Crypto per Kya, Chevrolet-Daewoo e Pontiac.

Clonazione telecomandi

- Stazione radio incorporata per clonazioni di telecomandi dei veicoli equipaggiati con transponder Philips® Crypto di II generazione tramite RK60, la nuova testa elettronica Keyline dotata di telecomando. RK60 è compatibile con tutti gli Horseshoe Keyline impiegati nei veicoli equipaggiati con transponder Philips® Crypto di II generazione.
- Modelli RFD100 e RFD80 per telecomandi Ford. Clonabili con 884 Decryptor Ultegra (RFD100) o programmabile a bordo veicolo (RFD80), garantiscono la sincronizzazione perfetta con il telecomando Ford originale, senza alterarne il funzionamento.

Altre funzioni

- Tastiera alfanumerica multifunzione.
- Connessioni RS232 e USB.
- Display grafico multilingua.
- Stessa antenna per tutti i tipi di transponder.
- Adattatore per alimentazione nel veicolo tramite presa accendisigari.

CARATTERISTICHE TECNICHE

Alimentazione	DC 12V; alimentatore universale incluso
Connessioni Esterne	Porta USB e seriale RS232
Assorbimento	20W
Dimensioni	Larghezza: 220 mm / Profondità: 130 mm / Altezza: 70 mm
Peso	1 Kg

KEYLINE NEW GENERATION POD KEYS (INSERT CAP) / KEYLINE POD KEYS DI NUOVA GENERAZIONE (CON TAPPO A INSERIMENTO)

Keyline has officially released a new generation of Pod Keys, all of which encompass the incomparable quality of Keyline's "Proudly Made in Italy" keys which is guaranteed by the certified materials and their expert mechanical precision.

The new generation Pod Keys are equipped with a comfortable universal transponder-holder which allows the use of glass and carbon transponder chips, original Keyline or compatible. A pinhole under the key head allows for easy and fast recovery of the chip.

All the new generation Pod Keys are identifiable in this catalogue thanks to the symbol  on the side of the key blade and their code ending in "TK".



Keyline ha lanciato una nuova generazione di Pod Keys, tutte con l'altissima qualità delle chiavi "Proudly Made in Italy" Keyline, garantita dai materiali certificati e da un'elevatissima precisione meccanica.

Le Pod Keys di nuova generazione sono dotate di un comodo porta-transponder universale che consente l'utilizzo di chip sia in vetro che in ceramica, originali Keyline o compatibili. Il foro posto sotto la testa permette di recuperare agevolmente il chip inserito.

Tutte le Pod Keys di nuova generazione con tappo a inserimento sono distinguibili in questo catalogo grazie al simbolo  posto a lato della canna della chiave e al codice che termina con "TK".

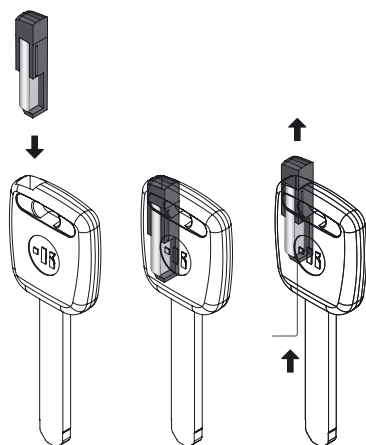
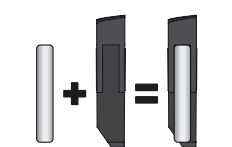

Glass transponder chip.
Transponder in vetro.

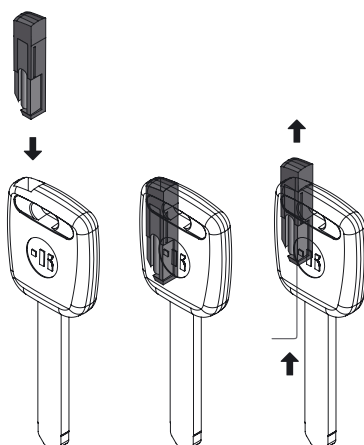
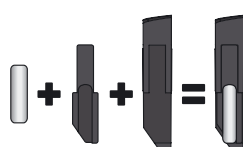

Glass transponder chip.
Transponder in vetro.

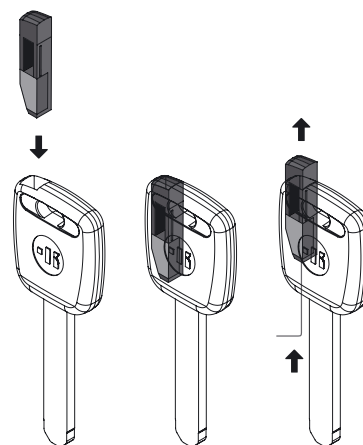
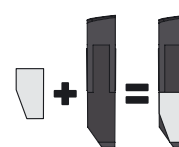

Carbon transponder chip.
Transponder in ceramica.

KEYLINE NEW GENERATION POD KEYS (SHELL TYPE) / KEYLINE POD KEYS DI NUOVA GENERAZIONE (CON GUSCIO)

Keyline has developed a new series of shell type Pod Keys completely dedicated to Japanese car models.

The new automotive keys, equipped with an empty plastic head and insert tray are designed to accommodate the GK100 glass chip and the CKG, CK100 and CK50 carbon chips.

The new Keyline Pod Keys are unique in the market, thanks to a thinner head with a reduced thickness of 6 mm that makes it perfectly compatible with the ignition lock slots of different Japanese car models, spread all over the world.

All Keyline Pod Keys are "Proudly Made in Italy", which guarantees certified materials and high mechanical precision.

It is possible to identify the new generation shell type Pod Keys thanks to the symbol  on the side of the key blade.



Keyline ha sviluppato una nuova serie di Pod Keys con guscio completamente dedicate ai modelli d'auto giapponesi.

Le nuove chiavi automotive dotate di testa plasticata cava sono progettate per contenere i transponder in vetro GK100 e i transponder in ceramica CKG, CK100 e CK50.

Le nuove Pod Keys Keyline sono uniche nel mercato, grazie alla testa in plastica con spessore ridotto a 6 mm che gli permette di essere perfettamente compatibili con gli alloggiamenti del blocchetto di accensione di diversi modelli d'auto giapponesi, diffusi in tutto il mondo.

Tutte le Pod Keys Keyline sono "Proudly Made in Italy", che garantisce materiali certificati e un'elevatissima precisione meccanica. È possibile distinguere le Pod Keys di nuova generazione con guscio grazie al simbolo  posto a lato della canna della chiave.

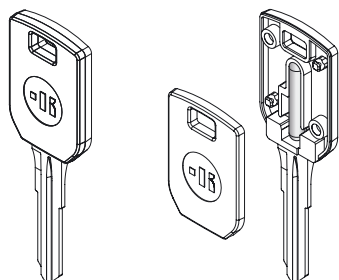

Glass transponder chip.
Transponder in vetro.

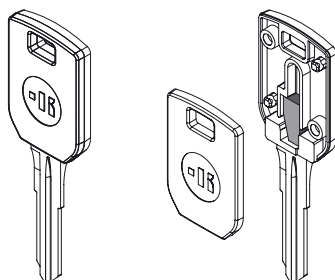

Carbon transponder chip.
Transponder in ceramica.

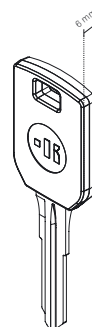
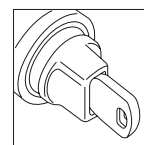

Thickness of 6 mm.
Spessore di 6 mm.

KEYLINE OLD GENERATION POD KEYS / KEYLINE POD KEYS DI VECCHIA GENERAZIONE

Keyline offers a wide range of Pod Keys, all of which encompass the incomparable quality of Keyline's "Proudly Made in Italy" keys which is guaranteed by the certified materials and their expert mechanical precision.

Keyline Pod Keys are automotive keys with an empty plastic head and insert tray designed to accommodate a programmable glass and carbon transponder chip.

Keyline original transponder chips do not require a battery, as they work through inductive coupling with the vehicle's control unit, and are available for the majority of the immobilizer systems on the market, including both fixed code and Crypto code.

Keyline offre una vastissima gamma di Pod Keys, tutte con l'altissima qualità delle chiavi "Proudly Made in Italy" Keyline, garantita dai materiali certificati e da un'elevatissima precisione meccanica.

Le Pod Keys Keyline sono chiavi automotive con testa plastificata cava progettate per contenere un transponder programmabile in vetro o ceramica.

I transponder originali Keyline non necessitano di batteria, funzionando per accoppiamento induttivo con la centralina auto e sono disponibili per la maggior parte dei sistemi immobilizer in circolazione, sia per la duplicazione a codice fisso che a codice Crypto.

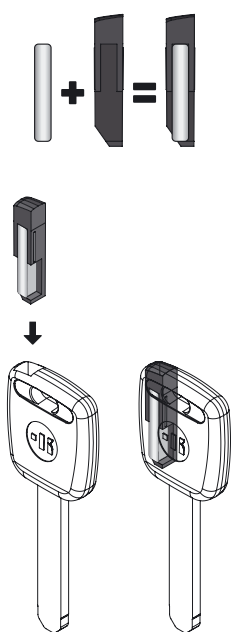

Insert cap / Con tappo a inserimento
Glass transponder chip.
Transponder in vetro.

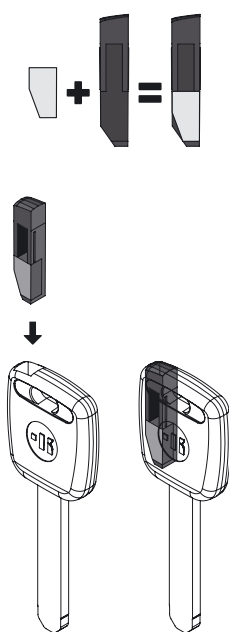

Insert cap / Con tappo a inserimento
Carbon transponder chip.
Transponder in ceramica.

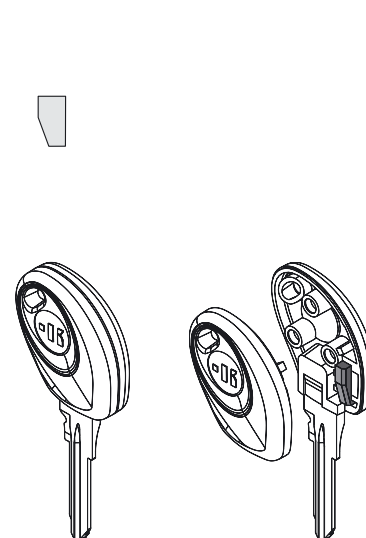

Shell type / Con guscio
Carbon transponder chip.
Transponder in ceramica.

KEYLINE UNIVERSAL POD KEYS + DEDICATED POD KEYS FITTING CARBON CHIP FORMAT / POD KEYS KEYLINE UNIVERSALI + POD KEYS KEYLINE COMPATIBILI CON TRANSPONDER IN CERAMICA

ARTICLE	ARTICLE	ARTICLE	ARTICLE
AD35TK-1*	HC1TK	PG30LTK-1*	VX1TK-9
AD66TK-1*	HD1BTK	PG31TK-1*	VX1TK-12
AR16TK-1*	HD70TK	PG33TK	VX2TK-1*
AR1505TK-1*	HD90TK	PG83TK	VX2TK-9
B106TK	HY6TK	RN30TK	VX3TK-5
BM2TK	HY7STK	RV3TK-1*	VX4TK-5
BM9TK	HY10TK	SK21STK-1*	VX4TK-12
CN22TK	HY12TK	SU15TK	VX5BTK
DAE46TK-1*	HY14TK	SU17TK	VX5TK-12
DAE46STK-1*	HY14STK	SU17STK	VX6BTK
DAE47TK	HY21TK	SU19TK	Y159TK - Grey
DAE47STK-1*	HY21STK	SU19JTK	Y159TK - Tan
DAE48TK-1*	ISU5TK	SUB1TK	Y170TK
DAE48STK-1*	KI3STK	SUB2TK	YM35TK
DAI1STK	KI4TK-13	SY3STK	YS15TK-1*
DAI2SJTK	LA1505TK-5**	TR12TK-5	ZAD18TK-5
DAI4STK-3	MT1BTK	TR41TK	
FC7TK	MT8SBTK	TR47TK	
FD3TK	MT11BTK	TR47STK	
FD20TK	MT15TK	TR48TK	
FD21BTK	MZ23TK-5	TR49TK	
FD40BTK	MZ24TK	TR51TK	
FD40TK-14	MZ27TK-5	TR56TK	
FD66TK-1*	NS2TK-1*	V35TK-1*	
FT20TK	NS2TK-11	V35TK-10	
FT22TK	NS2TK-13	V66TK	
FT50TK	NS3TK-1*	V70TK	
FT50ATK-5	NS3TK-11	VE20TK	
FT1505TK-5	NS3TK-13	VL10TK-1*	
FT1505ATK-5	NS27TK	VL15TK-1*	
FT1505BTK-5	NS34BTK	VL17TK-1*	
FT1505CTK	NS34JTK	VX1TK-1*	

* Discontinued transponder: Keyline doesn't supply this code anymore.

* Transponder discontinuato: Keyline non fornisce più questo codice.

** Discontinued product: Keyline doesn't supply this article anymore.

** Prodotto discontinuato: Keyline non fornisce più questo articolo.

KEYLINE MICRO SERIES / KEYLINE SERIE MICRO

GKM / GK100 / CKG / CK100 / CK50

Keyline's evolution is called Micro Series! The small dimension chips designed to quickly and easily clone a wide range of automotive car, motorbike and truck keys.

GKM the glass chip for cloning keys with Megamos® Crypto (ID48) and Megamos® fixed code transponders.

GK100 the glass chip for cloning keys with Philips® Crypto (ID46), Texas® Crypto (4D) and Texas® fixed code (4C) transponders.

CKG the carbon chip for cloning a large range of Texas® 80-bit transponders used by Kia®, Hyundai®, Ford® and Toyota® car models.

CK100 the carbon chip for cloning keys with Philips® Crypto (ID46), Texas® Crypto (4D) and Texas® fixed code (4C) transponders.

CK50 the carbon chip for cloning keys with first generation Philips® Crypto transponders (PH1B, PH1C, PH1D*, PH1E).

GKM, GK100, CKG, CK100 and **CK50** perfectly fit into Keyline Pod Keys, Keyline Flip Keys and Keyline TKXXGE heads equipped with the proper adaptor.

More than 100 Pod Key references available.

Full compatibility with Keyline cloning devices, 884 Decryptor Mini and 884 Decryptor Ultegra, creates a completely integrated system. It is immediate and easy to use: just insert GKM, GK100, CKG, CK100 or CK50 in the Keyline Pod Key, Keyline Flip Keys or in the Keyline TKXXGE head with adaptor and start cloning with 884 Decryptor Mini and 884 Decryptor Ultegra**.

To clone Megamos® Crypto (ID48) transponders with GKM it is necessary to purchase and activate your Keyline cloning devices with TKM. Xtreme Kit.

Resistant, versatile and capable to clone the widest range of car keys with transponders: the new Micro Series continues offering opportunities to all Automotive Professional Locksmiths.

GKM, GK100, CKG***, CK100 and CK50 are batteryless.

Micro dimensions, for Maximum cloning!



All the brands and trade marks mentioned here are the exclusive property of the respective car manufacturers or groups.
* 884 Decryptor Mini can't clone first generation Philips® Crypto transponder PH1D.
** The Keyline Software update is available on the www.keyline.it and www.keyline-usa.com websites.
*** CKG can be used only one time.



L'evoluzione Keyline si chiama Serie Micro! I chip dalle dimensioni ridotte per clonare subito e in modo semplice un'ampia gamma di chiavi elettroniche auto, moto e camion.

GKM, il chip in vetro per la clonazione di chiavi con transponder Megamos® Crypto (ID48) e Megamos® fissi.

GK100, il chip in vetro per la clonazione di chiavi con transponder Philips® Crypto (ID46), Texas® Crypto (4D) e Texas® fisso (4C).

CKG, chip in ceramica per la clonazione di chiavi con transponder Texas® 80-bit, per i modelli d'auto Kia®, Hyundai®, Ford® e Toyota®.

CK100, il chip in ceramica per la clonazione di chiavi con transponder Philips® Crypto (ID46), Texas® Crypto (4D) e Texas® fisso (4C).

CK50, chip in ceramica per la clonazione di buona parte delle chiavi con transponder Philips® Crypto di prima generazione (PH1B, PH1C, PH1D*, PH1E).

GKM, GK100, CKG, CK100 e **CK50** si integrano perfettamente con le Pod Keys, le Flip Keys e le teste Keyline TKXXGE dotate di apposito adattatore.

Più di 100 referenze Pod Keys disponibili.

Il sistema si completa grazie alla piena compatibilità con i dispositivi di clonazione Keyline, 884 Decryptor Mini e 884 Decryptor Ultegra. L'utilizzo è immediato e molto semplice: basta inserire GKM, GK100, CKG, CK100 o CK50 nella Pod Key, nella Flip Key o nella testa con adattatore Keyline TKXXGE e iniziare la clonazione con i dispositivi 884 Decryptor Mini e 884 Decryptor Ultegra**.

Per clonare i transponder Megamos® Crypto con GKM è necessario attivare i dispositivi Keyline con TKM. Xtreme Kit.

Resistenti, versatili e capaci della più ampia copertura nella clonazione di chiavi auto con transponder: la nuova Serie Micro offre sempre maggiori opportunità a tutti gli Specialisti.

GKM, GK100, CKG***, CK100 e CK50 non hanno bisogno di batteria.

Dimensioni Micro, per Maxi clonazioni!

Tutti i marchi e i marchi di fabbrica qui pubblicati sono marchi registrati e di esclusiva proprietà delle rispettive case o gruppi automobilistici.
* 884 Decryptor Mini non è in grado di clonare i transponder Philips® Crypto di prima generazione PH1D.
** L'aggiornamento del Software Keyline è disponibile nei siti www.keyline.it e www.keyline-usa.com
*** Il chip CKG è utilizzabile una sola volta.

LEGEND / LEGENDA

FD21B

Identifying code for profiles
Codice identificativo per profili



Head
Testa

Old generation pod key (insert cap)
Pod key di vecchia generazione (con tappo a inserimento)

Old generation pod key (shell type)
Pod key di vecchia generazione (con guscio)

New generation pod key (insert cap)
Pod key di nuova generazione (con tappo a inserimento)

New generation pod key (shell type)
Pod key di nuova generazione (con guscio)

Glass transponder chip
Transponder in vetro

Glass transponder chip
Transponder in vetro

Carbon transponder chip
Transponder in ceramica

Blade
Canna

Profile
Profilo

FD21BTK

Keyline article (molded on the head of the key)
Articolo Keyline (impresso sulla testa della chiave)

TRANSPONDER TYPE

MEG	Transponder Megamos®
MEG/CRY	Transponder Megamos® Crypto
PH	Transponder Philips®
PH/CRY	Transponder Philips® Crypto
TEMIC	Transponder Temic®
TEX	Transponder Texas®
TEX/CRY	Transponder Texas® Crypto

KEYLINE MICRO SERIES

M	Transponder Megamos®, Megamos® Crypto
●	Transponder Megamos®, Megamos® Crypto
P	Transponder Philips®, Philips® Crypto, Temic®
▲	Transponder Philips®, Philips® Crypto, Temic®
T	Transponder Texas®, Texas® Crypto
■	Transponder Texas®, Texas® Crypto

TRANSPONDER MODELS FOR POD KEYS / MODELLI TRANSPONDER PER POD KEYS

Keyline	Generic / Generico	Description / Descrizione	ID 884	ID Generic / ID Generico	Material / Materiale
TK-1*	T1	Philips® (F.C.)	PH00	33	 carbon
TK-1*	T2	Philips® (F.C.)	PH00	33	 carbon
TK-2	T3	Texas® (R.O.F.C.)	TX00	4C	 glass
TK-3	T4	Texas® (R.O.F.C.)	TX00	4C	 carbon
TK-4	T8	Texas® Crypto (Renault - Chrysler)	TC04	4D	 carbon
TK-5	T5	Sokymat (R.W.F.C.)	0000	21-22-23	 carbon
TK-6*	-	Temic® (F.C.) - Fiat	TM10	11	 glass
TK-7	T7	Texas® Crypto (Ford)	TC01	4D	 glass
TK-8	T6	Megamos® Crypto (VAG < 2003)	MG10	48	 glass
TK-9	T9	Philips® Crypto (Opel - Vauxhall)	PH1A	40	 carbon
TK-10	T10	Philips® Crypto 1 (VW)	PH1C	42	 carbon
TK-11	T11	Philips® Crypto 1 (Nissan)	PH1B	41	 carbon
TK-12	T12	Philips® Crypto Gold (Opel - Vauxhall)	PH1A	40	 carbon
TK-13	T13	Texas® Crypto (Nissan - Mitsubishi)	TC07	4D	 carbon
TK-14	T17	Texas® Crypto (Ford - Mazda)	TC08	4D	 carbon
TK-15	T5	Sokymat (R.W.F.C.)	0000	21-22-23	 glass
TK-16	T14	Philips® Crypto 2 (PSA - Chrysler - Honda - Mitsubishi)	PH20	46	 carbon
TK-17	T15	Philips® Crypto 1 (Ford - VW)	PH10	44	 carbon
TK-18*	T18	Texas® Crypto (Suzuki)	TC02	4D	 carbon
TK-19*	T19	Texas® Crypto (Mitsubishi)	TPXX	4D	 carbon
TK-20	-	Megamos® (R.O.F.C.)	MG00	13	 glass
TK-21*	T16	Texas® Crypto (Renault)	TC03	4D	 carbon
TK-22*	T20	Texas® Crypto (Ford Australia)	TPXX	4D	 carbon
TK-26*	-	Temic® (R.O.F.C.) - Mazda	TM20	12	 glass
TK-27*	-	Temic® Crypto (Mazda - Proton)	TM01	8C	 carbon
TK-28	-	Philips® Crypto 3	PH30	-	 carbon
TK-50*	T28	Philips® Crypto 1 (PH1D - PH1E)	TK50	XX	 carbon

* Discontinued transponder: Keyline doesn't supply this code anymore.

* Transponder discontinuato: Keyline non fornisce più questo codice.

All the brands and trade marks mentioned here are the exclusive property of the respective car manufacturers or groups.

Tutti i marchi e i marchi di fabbrica qui pubblicati sono marchi registrati e di esclusiva proprietà delle rispettive case o gruppi automobilistici.



Keyline keys are manufactured exclusively with **high quality prime materials**:

- OT59 alloy Brass, as used in the watchmaking industry;
- 7075 T6 alloy Aluminum, as used in the aeronautical engineering sector;
- Steel, reliable, durable and smooth for the key cutting operation;
- and Nickel Silver, as used in jewelry manufacturing.

All these materials are particularly suitable for the milling/cutting operations.

Le **chiavi Keyline** sono prodotte esclusivamente con **materie prime di alta qualità**:

- Ottone in lega OT59, usato nel settore dell'orologeria;
- Alluminio in lega 7075 T6, usato nell'industria dell'ingegneria aeronautica;
- Acciaio, affidabile, resistente e liscio per le operazioni di taglio chiave;
- Alpacca, usato nella produzione di gioielli.

Tutti questi materiali sono particolarmente adatti per le operazioni di fresatura e taglio.



A BIANCHI 1770 GROUP COMPANY

POD KEYS DI NUOVA GENERAZIONE

NEW GENERATION POD KEYS

POD KEYS DER NEUEN GENERATION

NOUVELLE GÉNÉRATION DE POD KEYS

NUEVA GENERACIÓN DE LLAVES POD



BIANCHI 1770 GROUP

Innovators by design | Since 1770



B106

BM2

BM9

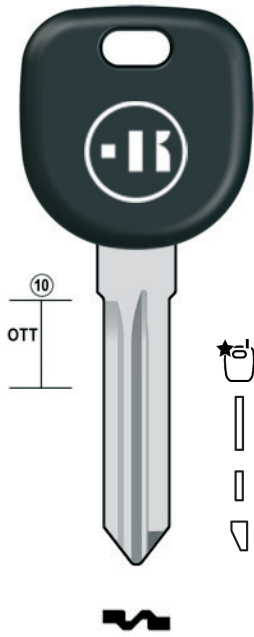

B106TK

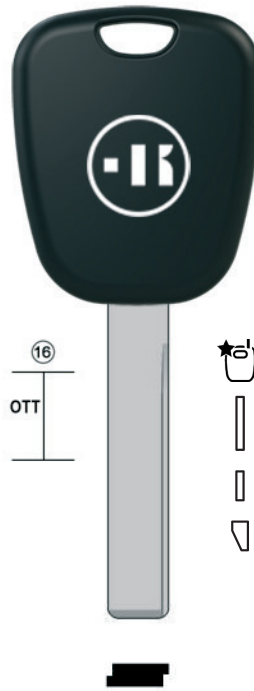

BM2TK

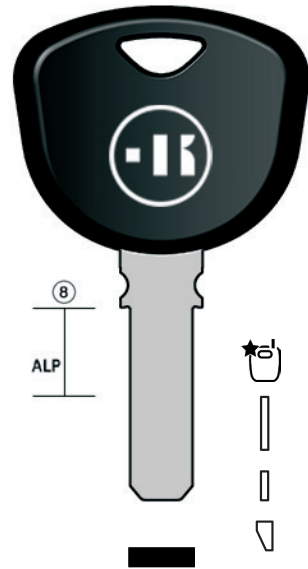

BM9TK

CN22

DAE47

DAI1S

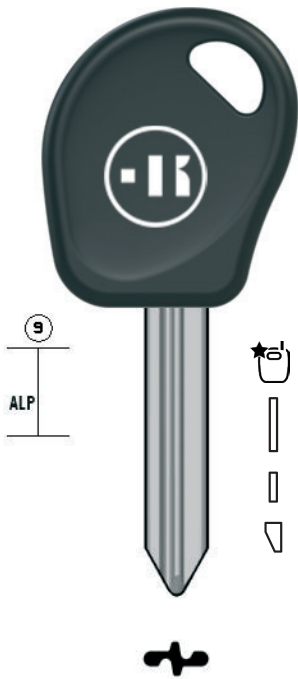

CN22TK

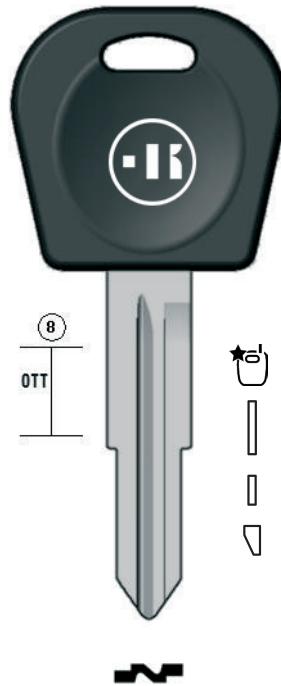

DAE47TK

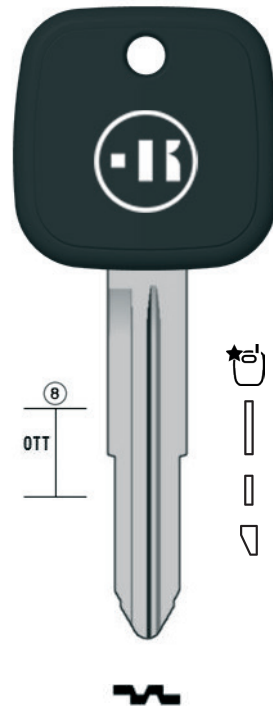

DAI1STK

DAI2SJ

FC7

FD3

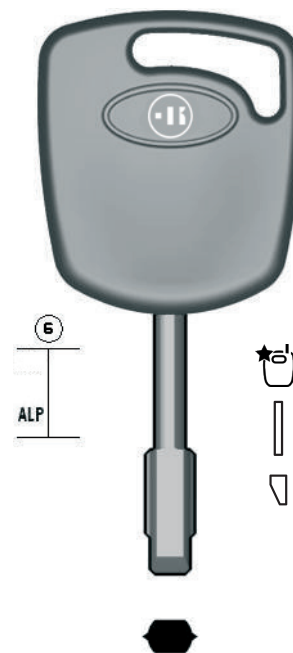
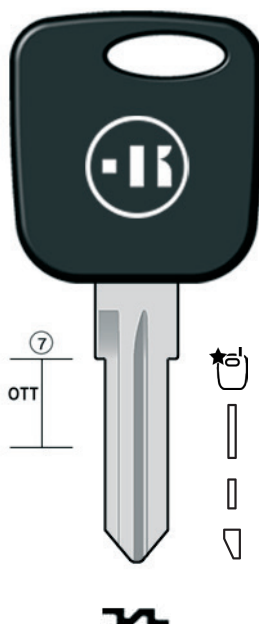
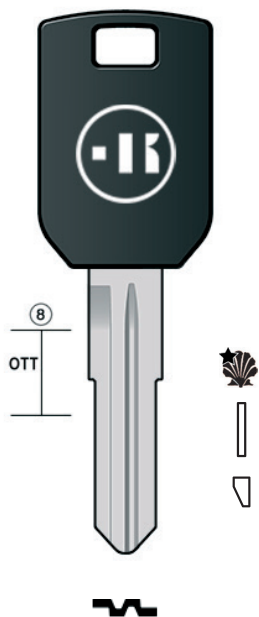

DAI2SJTK

FC7TK

FD3TK

FD20

FD21B

FD40B

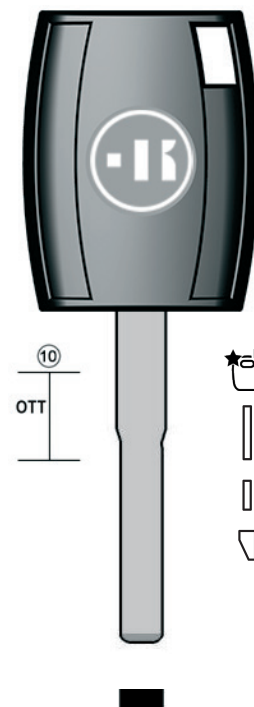
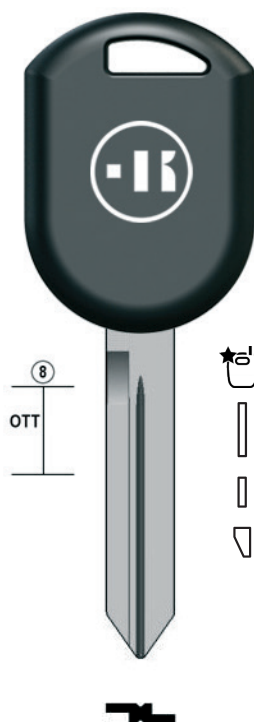
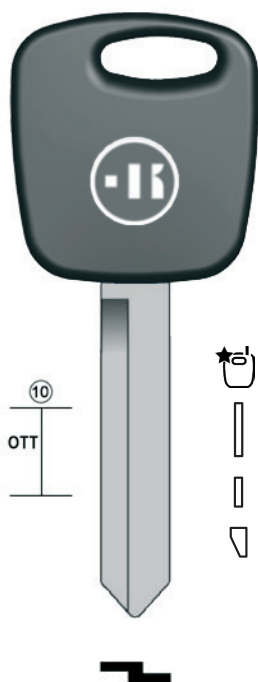

FD20TK

FD21BTK

FD40BTK

FT20

FT22

FT50

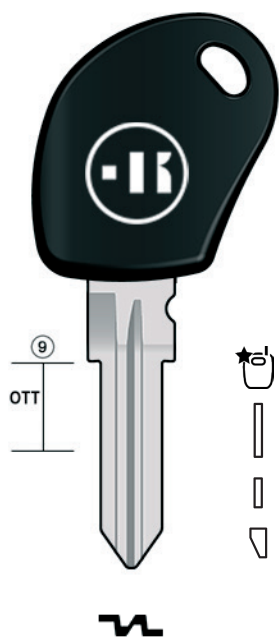

FT20TK

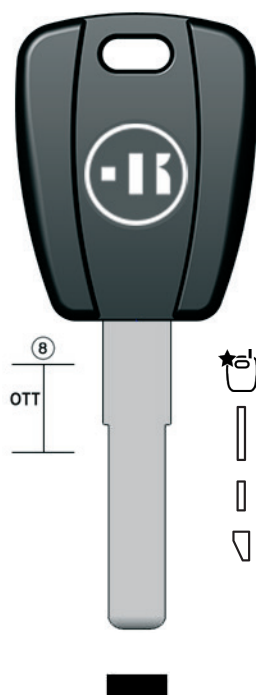

FT22TK

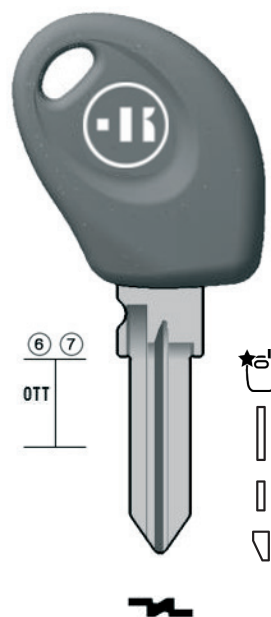

FT50TK

FT1505C

HC1

HD1B

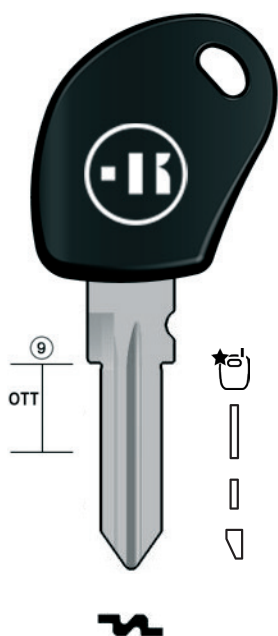

FT1505CTK

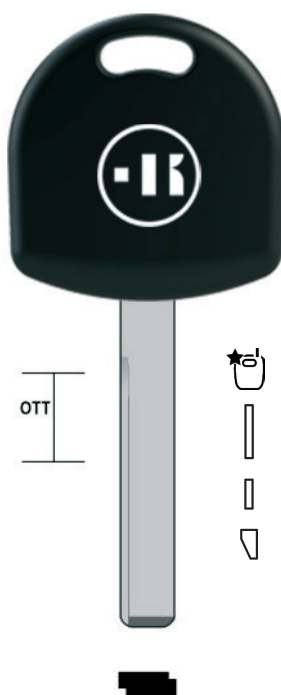

HC1TK

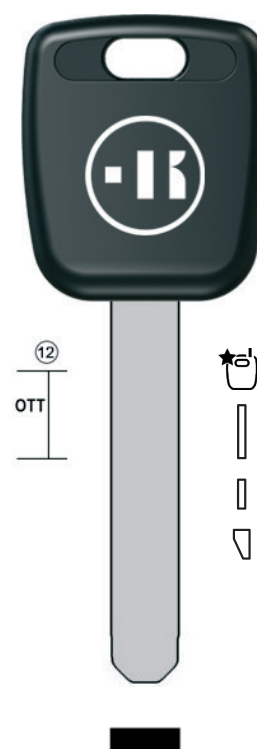

HD1BTK

HD70

HD90

HY6

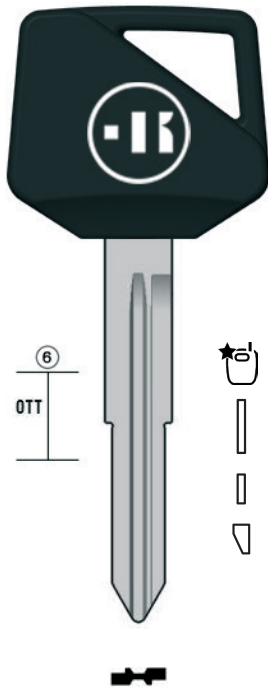

HD70TK

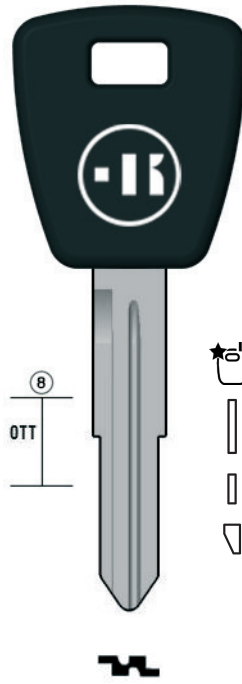

HD90TK

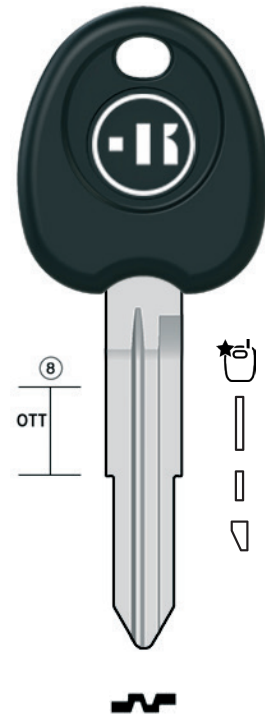

HY6TK

HY7S

HY10

HY12

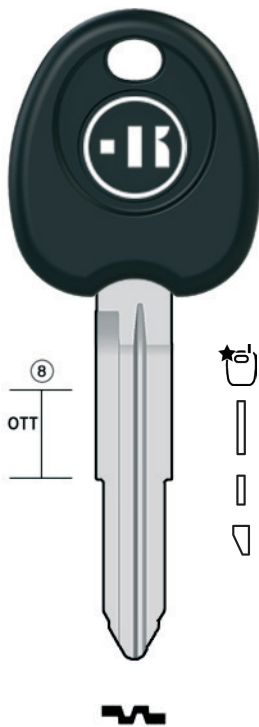

HY7STK

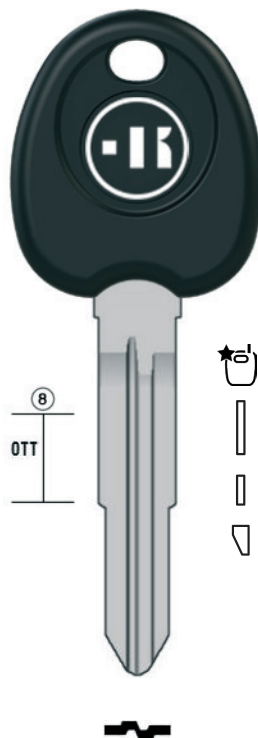

HY10TK

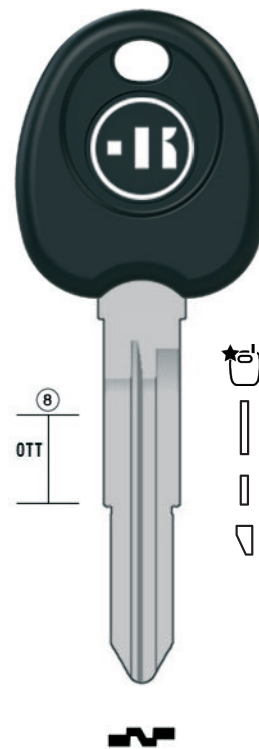

HY12TK

HY14

HY14S

HY21

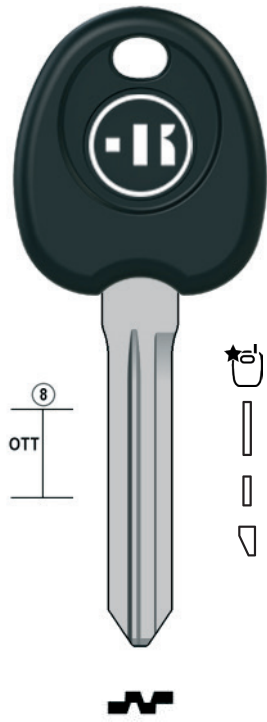

HY14TK

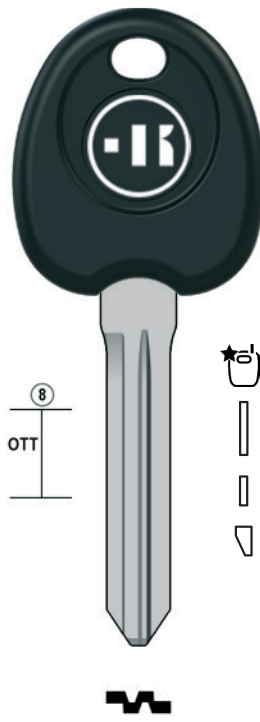

HY14STK

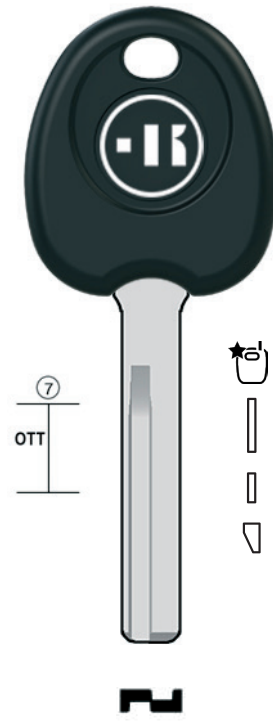

HY21TK

HY21S

ISU5

KI3S

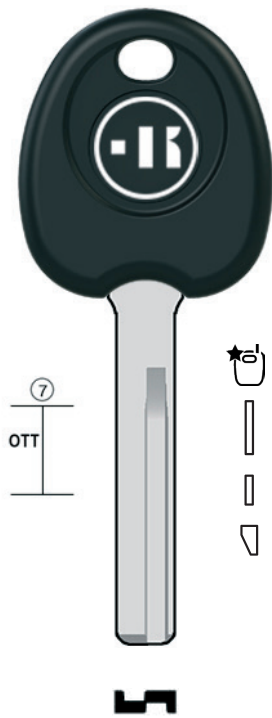

HY21STK

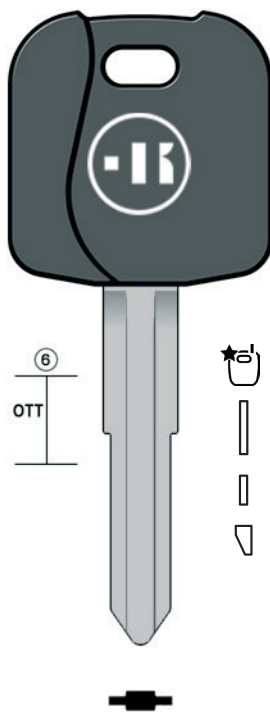

ISU5TK

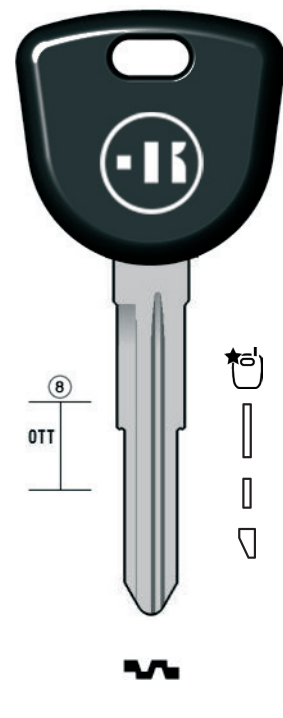

KI3STK

MT15

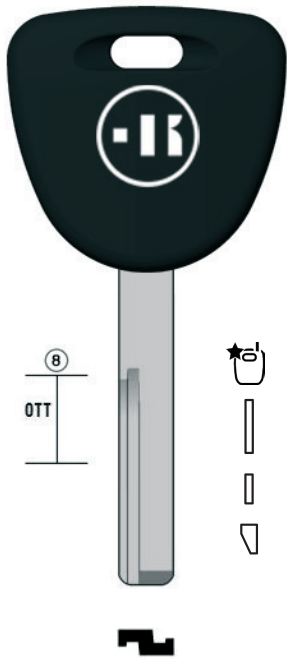

MT15TK

MT1B

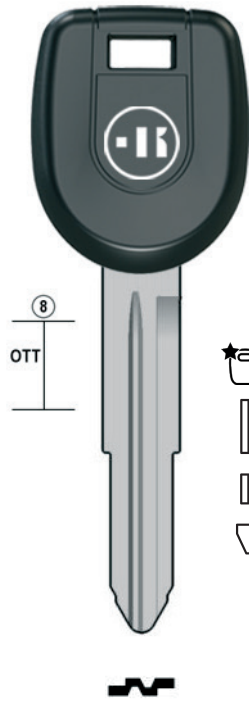

MT1BTK

MT11B

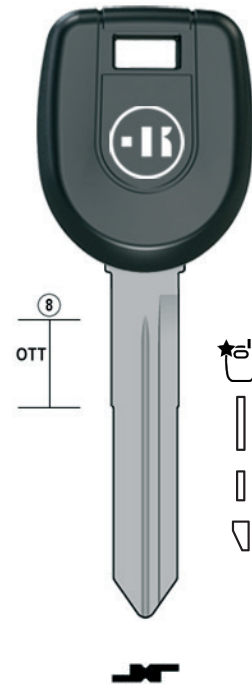

MT11BTK

MT8SB

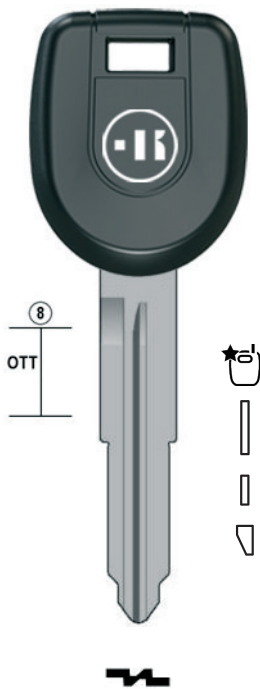

MT8SBTK

MZ24

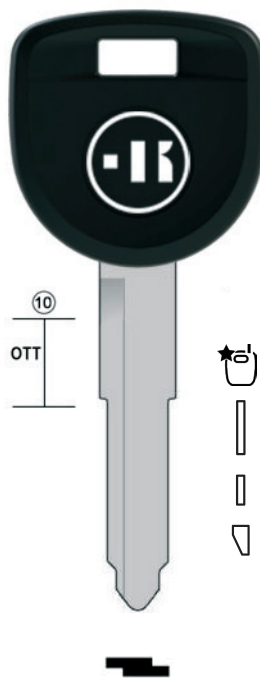

MZ24TK

NS27

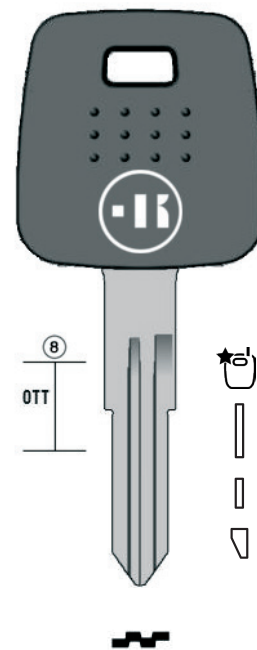

NS27TK

NS34B

NS34J

PG33

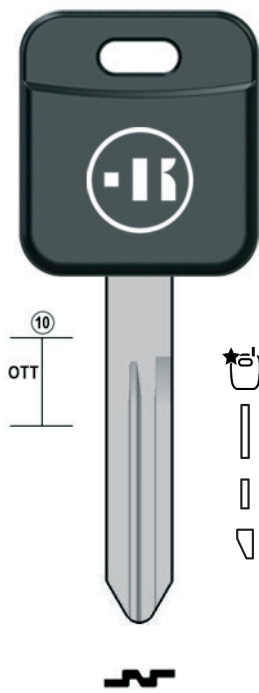

NS34BTK

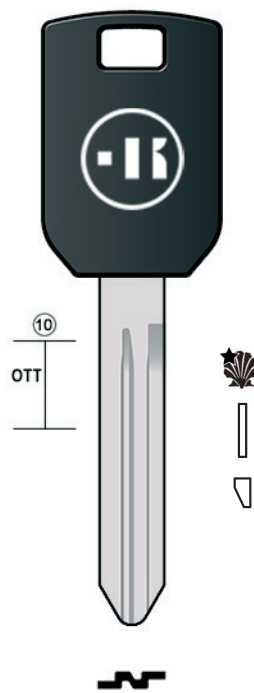

NS34JTK

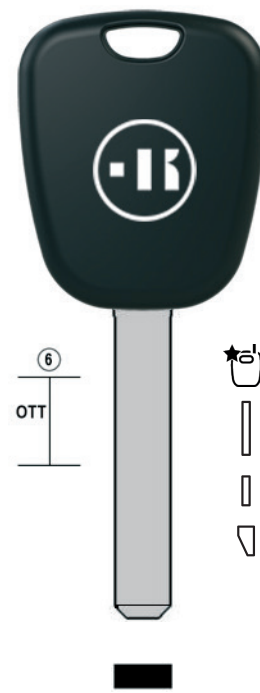

PG33TK

PG83

RN30

SU15



PG83TK

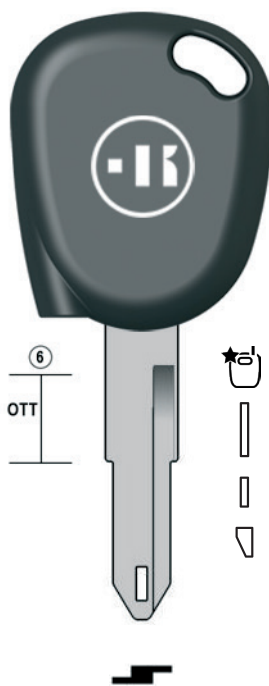

RN30TK

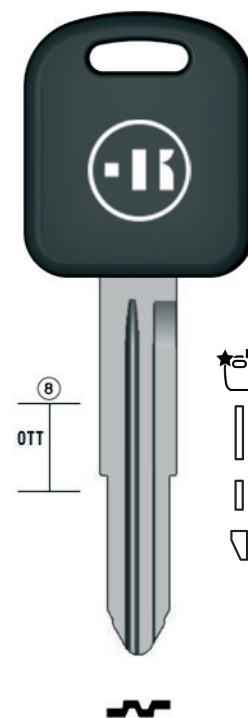

SU15TK

SU17

SU17S

SU19

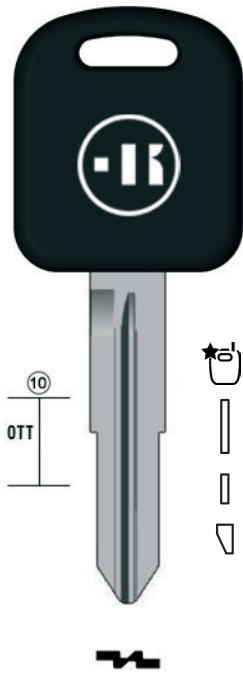

SU17TK

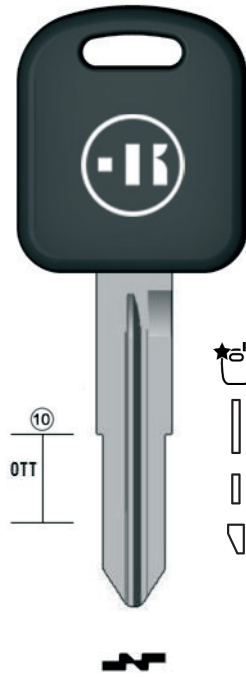

SU17STK

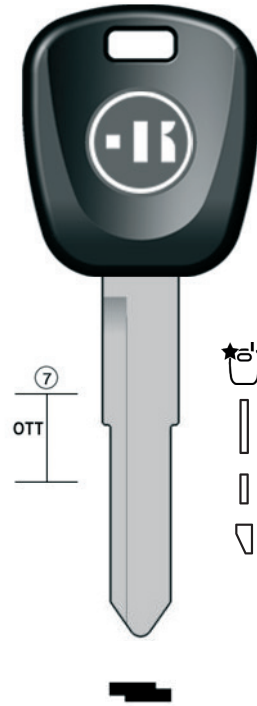

SU19TK

SU19J

SUB1

SUB2

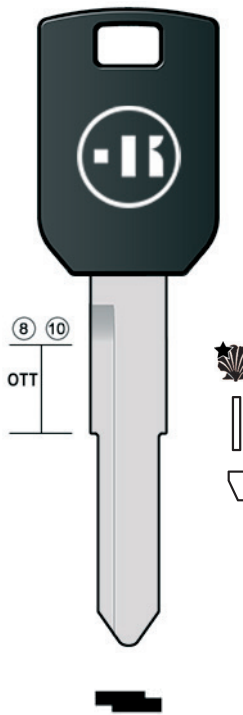

SU19JTK

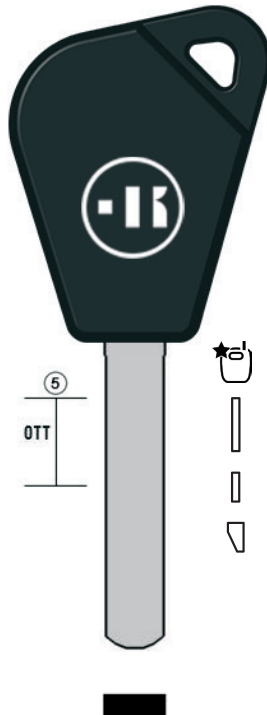

SUB1TK

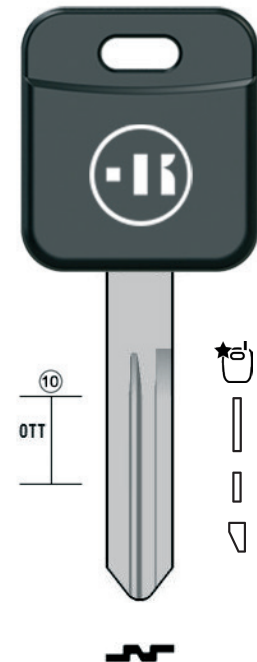

SUB2TK

SY3S

TR41

TR47

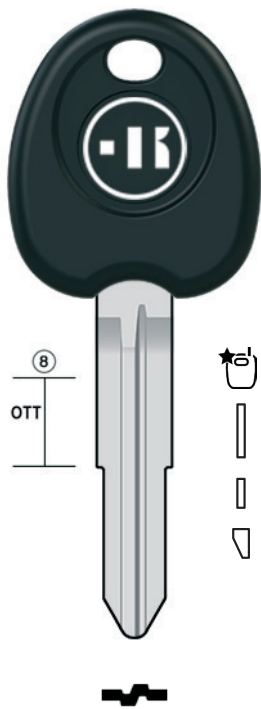

SY3STK

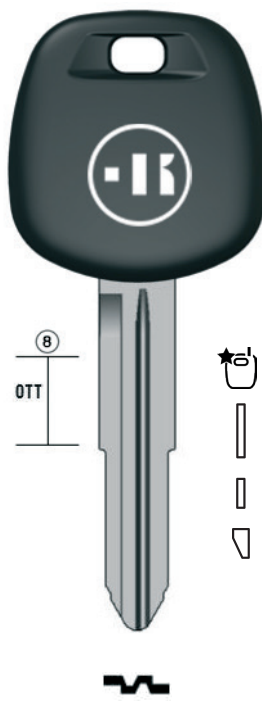

TR41TK

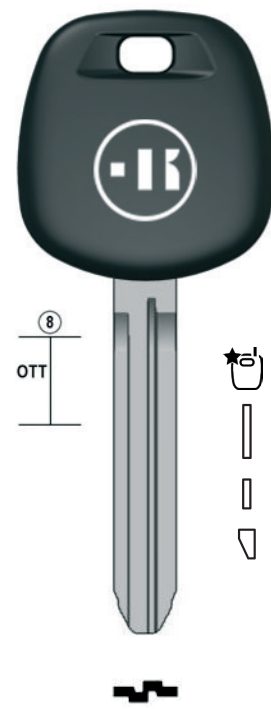

TR47TK

TR47S

TR48

TR49

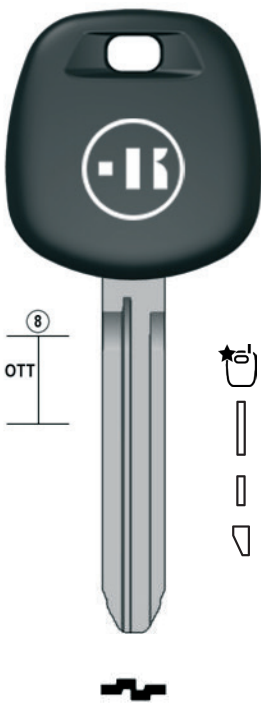

TR47STK

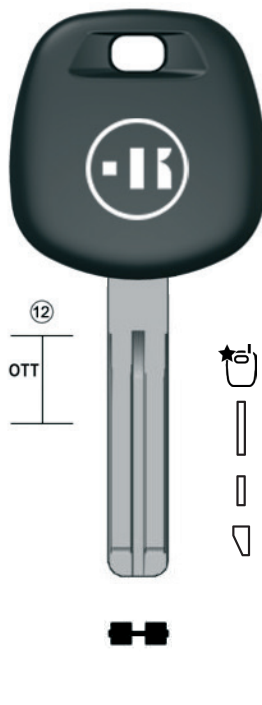

TR48TK

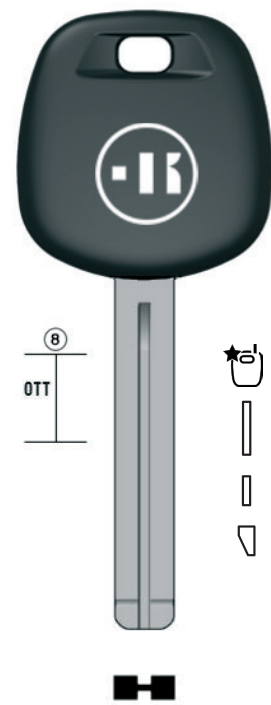

TR49TK

TR51

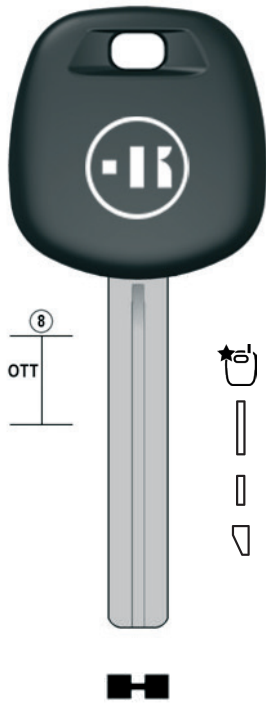

TR51TK

TR56

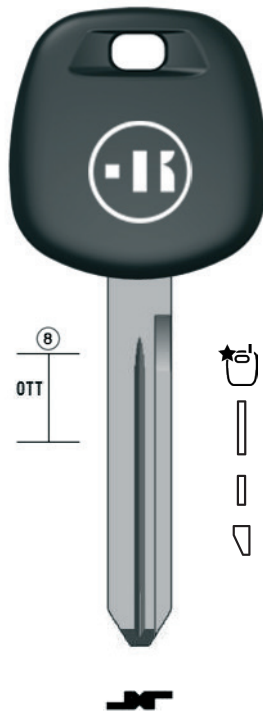

TR56TK

V66

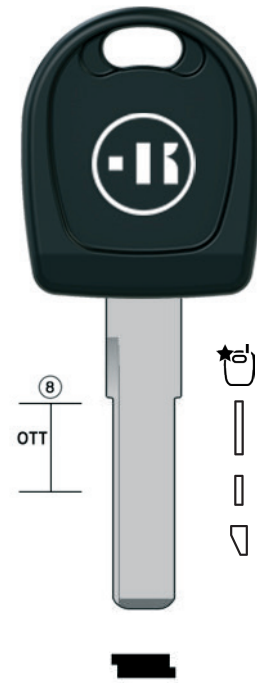

V66TK

V70

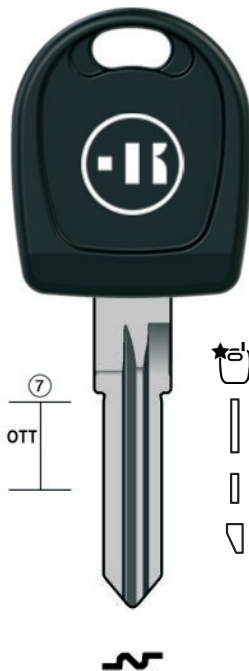

V70TK

VE20

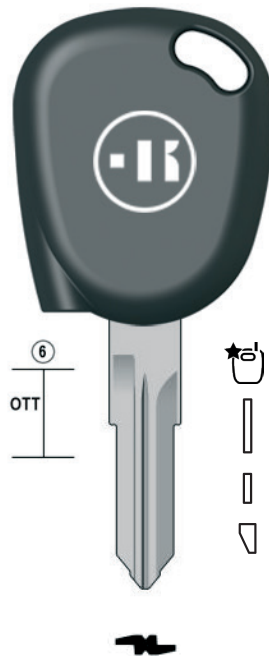

VE20TK

VX5B

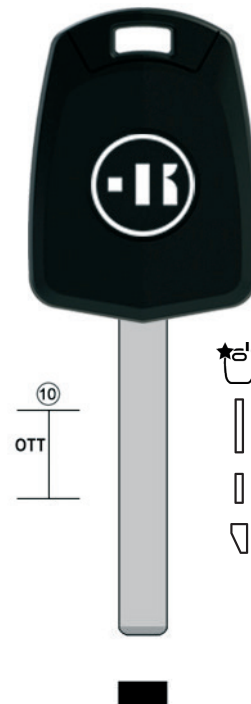

VX5BTK

VX6B

Y159

Y170

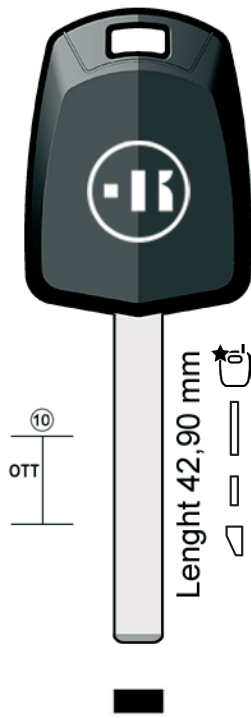

VX6BTK

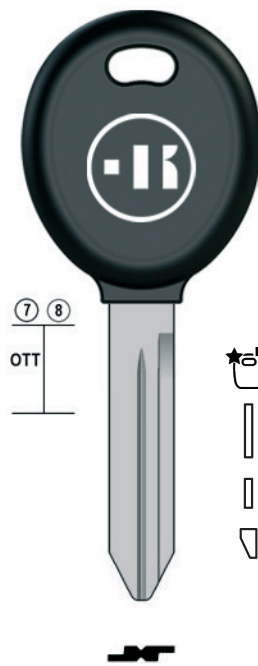

Y159TK - Grey
Y159TK - Tan

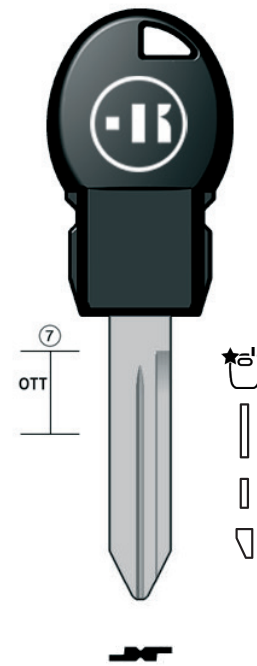

Y170TK

YM35

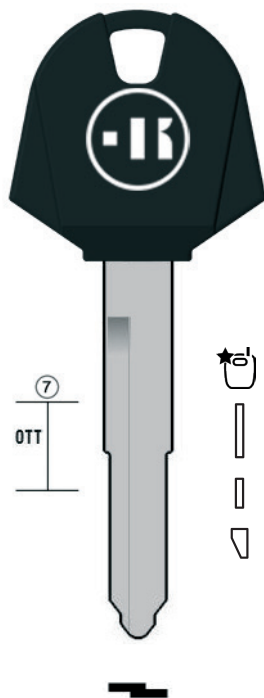

YM35TK

INDEX - INDICE

MODEL	YEAR	KEYLINE REFERENCE	KEYLINE MICRO SERIES			TRANS. TYPE	ID	PAGE	CROSS REFERENCE OF SUBSTITUTE (WHERE AVAILABLE)	
			T	P	M					
ABARTH (I)										
500	08	-	FT22TK		▲	Ph/Cry	PH20	4	SIP22TE	TP00FI16.P
Grande Punto	07	10	FT22TK		▲	Ph/Cry	PH20	4	SIP22TE	TP00FI16.P
Punto Evo	10	-	FT22TK		▲	Ph/Cry	PH20	4	SIP22TE	TP00FI16.P
ACURA (USA)										
CL	98	03	HD90TK		●	Meg	MG00	5	HON58RTE	TP00HOND-21.P
CSX (Canada)	06	11	HD1BTK		▲	Ph/Cry	PH20	4	HON66TE	TP00HOND-31.P
Integra	00	01	HD90TK		●	Meg	MG00	5	HON58RTE	TP00HOND-21.P
MDX	01	06	HD90TK		●	Meg	MG00	5	HON58RTE	TP00HOND-21.P
MDX	07	-	HD1BTK		▲	Ph/Cry	PH20	4	HON66TE	TP00HOND-31.P
NSX	97	05	HD90TK		●	Meg	MG00	5	HON58RTE	TP00HOND-21.P
RDX	07	-	HD1BTK		▲	Ph/Cry	PH20	4	HON66TE	TP00HOND-31.P
RL	96	04	HD90TK		●	Meg	MG00	5	HON58RTE	TP00HOND-21.P
RSX	02	06	HD90TK		●	Meg	MG00	5	HON58RTE	TP00HOND-21.P
TL	99	03	HD90TK		●	Meg	MG00	5	HON58RTE	TP00HOND-21.P
TL	07	-	HD1BTK		▲	Ph/Cry	PH20	4	HON66TE	TP00HOND-31.P
TSX	09	-	HD1BTK		▲	Ph/Cry	PH20	4	HON66TE	TP00HOND-31.P
ZDX	10	-	HD1BTK		▲	Ph/Cry	PH20	4	HON66TE	TP00HOND-31.P
ALFA ROMEO (I)										
147	98	-	FT22TK		●	Meg/Cry	MG10	4	SIP22TE	TP00FI16.P
156	01	03	FT22TK		▲	Ph/Cry	PH20	4	SIP22TE	TP00FI16.P
156	03	05	FT22TK		●	Meg/Cry	MG10	4	SIP22TE	TP00FI16.P
166	04	08	FT22TK		▲	Ph/Cry	PH20	4	SIP22TE	TP00FI16.P
156 Sport Wagon	01	07	FT22TK		▲	Ph/Cry	PH20	4	SIP22TE	TP00FI16.P
Giulietta	10	-	FT22TK		▲	Ph/Cry	PH20	4	SIP22TE	TP00FI16.P
GT	04	-	FT22TK		●	Meg/Cry	MG10	4	SIP22TE	TP00FI16.P
MiTo	08	-	FT22TK		▲	Ph/Cry	PH20	4	SIP22TE	TP00FI16.P
Spider	06	-	FT22TK		▲	Ph/Cry	PH20	4	SIP22TE	TP00FI16.P
AUDI (D)										
A1	10	-	V66TK		●	Meg/Cry	MG10	11	HU66TE	TP00HU-HAA.P
A2	00	05	V66TK		●	Meg/Cry	MG10	11	HU66TE	TP00HU-HAA.P
A3	97	-	V66TK		●	Meg/Cry	MG10	11	HU66TE	TP00HU-HAA.P
A4	97	-	V66TK		●	Meg/Cry	MG10	11	HU66TE	TP00HU-HAA.P
A4 Cabrio	97	-	V66TK		●	Meg/Cry	MG10	11	HU66TE	TP00HU-HAA.P
A6	97	-	V66TK		●	Meg/Cry	MG10	11	HU66TE	TP00HU-HAA.P
A8	97	-	V66TK		●	Meg/Cry	MG10	11	HU66TE	TP00HU-HAA.P
Allroad	00	-	V66TK		●	Meg/Cry	MG10	11	HU66TE	TP00HU-HAA.P
Coupé	97	-	V66TK		●	Meg/Cry	MG10	11	HU66TE	TP00HU-HAA.P
Q3	11	14	V66TK		●	Meg/Cry	MG10	11	HU66TE	TP00HU-HAA.P
Q7	06	-	V66TK		●	Meg/Cry	MG10	11	HU66TE	TP00HU-HAA.P
S2	97	-	V66TK		●	Meg/Cry	MG10	11	HU66TE	TP00HU-HAA.P
S3	01	-	V66TK		●	Meg/Cry	MG10	11	HU66TE	TP00HU-HAA.P
S4	02	-	V66TK		●	Meg/Cry	MG10	11	HU66TE	TP00HU-HAA.P
S6	97	-	V66TK		●	Meg/Cry	MG10	11	HU66TE	TP00HU-HAA.P
S8	98	-	V66TK		●	Meg/Cry	MG10	11	HU66TE	TP00HU-HAA.P

MODEL	YEAR	KEYLINE REFERENCE	KEYLINE MICRO SERIES			TRANS. TYPE	ID	PAGE	CROSS REFERENCE OF SUBSTITUTE (WHERE AVAILABLE)		
			T	P	M						
AUDI (D)											
TT	98	-	V66TK			●	Meg/Cry	MG10	11	HU66TE	TP00HU-HAA.P
BMW (D)											
C600 Sport	12	-	BM9TK	▲			Ph/Cry	PH20	2	BW9TE	TP00BM-7P
C650 GT	12	-	BM9TK	▲			Ph/Cry	PH20	2	BW9TE	TP00BM-7P
F650	08	11	BM9TK	▲			Ph/Cry	PH20	2	BW9TE	TP00BM-7P
F800	06	-	BM9TK	▲			Ph/Cry	PH20	2	BW9TE	TP00BM-7P
G650	11	-	BM9TK	▲			Ph/Cry	PH20	2	BW9TE	TP00BM-7P
K1200	05	08	BM9TK	▲			Ph/Cry	PH20	2	BW9TE	TP00BM-7P
K1300	09	-	BM9TK	▲			Ph/Cry	PH20	2	BW9TE	TP00BM-7P
K1600	11	-	BM9TK	▲			Ph/Cry	PH20	2	BW9TE	TP00BM-7P
R1200	05	-	BM9TK	▲			Ph/Cry	PH20	2	BW9TE	TP00BM-7P
Serie 1	04	11	BM2TK	▲			Ph/Cry	PH20	2	HU92RTE	TP00BM.6P
Serie 3	05	11	BM2TK	▲			Ph/Cry	PH20	2	HU92RTE	TP00BM.6P
Serie 5	03	10	BM2TK	▲			Ph/Cry	PH20	2	HU92RTE	TP00BM.6P
Serie 6	04	11	BM2TK	▲			Ph/Cry	PH20	2	HU92RTE	TP00BM.6P
Serie 7	02	08	BM2TK	▲			Ph/Cry	PH20	2	HU92RTE	TP00BM.6P
X5	04	11	BM2TK	▲			Ph/Cry	PH20	2	HU92RTE	TP00BM.6P
Z4	06	11	BM2TK	▲			Ph/Cry	PH20	2	HU92RTE	TP00BM.6P
BUICK (USA)											
Enclave	08	-	B106TK	▲			Ph/Cry	PH20	2	-	-
Lucerne	06	-	B106TK	▲			Ph/Cry	PH20	2	-	-
CADILLAC (USA)											
CTS	08	-	B106TK	▲			Ph/Cry	PH20	2	-	-
DTS	06	-	B106TK	▲			Ph/Cry	PH20	2	-	-
Escalade	07	-	B106TK	▲			Ph/Cry	PH20	2	-	-
Escalade EXT	07	-	B106TK	▲			Ph/Cry	PH20	2	-	-
SRX	07	09	B106TK	▲			Ph/Cry	PH20	2	-	-
STS	05	-	B106TK	▲			Ph/Cry	PH20	2	-	-
XLR	04	09	B106TK	▲			Ph/Cry	PH20	2	-	-
CHEVROLET (USA)											
Avalanche	07	-	B106TK	▲			Ph/Cry	PH20	2	-	-
Cobalt	06	-	B106TK	▲			Ph/Cry	PH20	2	-	-
Epica	04	07	DAE47TK			●	Meg	MG00	2	DWO5TE	TP00DAE-4.P1
Equinox	07	09	B106TK	▲			Ph/Cry	PH20	2	-	-
Express	08	-	B106TK	▲			Ph/Cry	PH20	2	-	-
HHR	06	-	B106TK	▲			Ph/Cry	PH20	2	-	-
Impala	06	-	B106TK	▲			Ph/Cry	PH20	2	-	-
Malibu	04	-	B106TK	▲			Ph/Cry	PH20	2	-	-
Montecarlo	06	07	B106TK	▲			Ph/Cry	PH20	2	-	-
Silverado (HD)	07	-	B106TK	▲			Ph/Cry	PH20	2	-	-
Suburban	07	-	B106TK	▲			Ph/Cry	PH20	2	-	-
Tahoe	07	-	B106TK	▲			Ph/Cry	PH20	2	-	-
Trailblazer	06	-	B106TK	▲			Ph/Cry	PH20	2	-	-
Traverse	09	-	B106TK	▲			Ph/Cry	PH20	2	-	-
CHRYSLER (USA)											
200 (S)	11	14	Y159TK - Tan	▲			Ph/Cry	PH20	12	CY24TE	TP00CHR-15.P
200 Conv. (S)	11	12	Y159TK - Tan	▲			Ph/Cry	PH20	12	CY24TE	TP00CHR-15.P
300, 300C	05	07	Y159TK - Tan	▲			Ph/Cry	PH20	12	CY24TE	TP00CHR-15.P
300, 300C	08	-	Y170TK	▲			Ph/Cry	PH20	12	EK3P-Y170	-

MODEL	YEAR	KEYLINE REFERENCE	KEYLINE MICRO SERIES			TRANS. TYPE	ID	PAGE	CROSS REFERENCE OF SUBSTITUTE (WHERE AVAILABLE)	
			T	P	M					
CHRYSLER (USA)										
300M	99	04	Y159TK - Grey	■		Tex/Cry	TCXX	12	CY24TE	TP00CHR-15.P
Aspen	07	09	Y159TK - Tan		▲	Ph/Cry	PH20	12	CY24TE	TP00CHR-15.P
Cirrus	99	00	Y159TK - Grey	■		Tex/Cry	TCXX	12	CY24TE	TP00CHR-15.P
Concorde	98	04	Y159TK - Grey	■		Tex/Cry	TCXX	12	CY24TE	TP00CHR-15.P
LHS	99	01	Y159TK - Grey	■		Tex/Cry	TCXX	12	CY24TE	TP00CHR-15.P
Neon (Canada)	00	02	Y159TK - Grey	■		Tex/Cry	TCXX	12	CY24TE	TP00CHR-15.P
Pacifica	04	08	Y159TK - Tan		▲	Ph/Cry	PH20	12	CY24TE	TP00CHR-15.P
PT Cruiser	01	05	Y159TK - Grey	■		Tex/Cry	TCXX	12	CY24TE	TP00CHR-15.P
PT Cruiser	06	10	Y159TK - Tan		▲	Ph/Cry	PH20	12	CY24TE	TP00CHR-15.P
Sebring Conv.	98	06	Y159TK - Grey	■		Tex/Cry	TCXX	12	CY24TE	TP00CHR-15.P
Sebring Conv.	08	10	Y159TK - Tan		▲	Ph/Cry	PH20	12	CY24TE	TP00CHR-15.P
Sebring Coupe	01	02	MT11BTK	■		Tex/Cry	TC07	7	-	TP00MIT-18.P
Sebring Sedan	01	06	Y159TK - Grey	■		Tex/Cry	TCXX	12	CY24TE	TP00CHR-15.P
Sebring Sedan	07	10	Y159TK - Tan		▲	Ph/Cry	PH20	12	CY24TE	TP00CHR-15.P
Town & Country	01	03	Y159TK - Grey	■		Tex/Cry	TCXX	12	CY24TE	TP00CHR-15.P
Town & Country	04	07	Y159TK - Tan		▲	Ph/Cry	PH20	12	CY24TE	TP00CHR-15.P
Town & Country	07	-	Y170TK		▲	Ph/Cry	PH20	12	EK3P-Y170	-
Voyager	01	03	Y159TK - Grey	■		Tex/Cry	TCXX	12	CY24TE	TP00CHR-15.P
CITROËN (F)										
Berlingo	98	01	CN22TK			Ph	PH00	2	SIX9TE	TP00SIX-3.P3
Berlingo	01	02	CN22TK		▲	Ph/Cry	PH20	2	SIX9TE	TP00SIX-3.P3
C1	05	-	PG33TK	■		Tex/Cry	TCXX	8	-	TP00CIT-1.P
C2	03	-	PG33TK		▲	Ph/Cry	PH20	8	-	TP00CIT-1.P
C3	02	-	PG33TK		▲	Ph/Cry	PH20	8	-	TP00CIT-1.P
C3-Picasso	08	-	PG33TK		▲	Ph/Cry	PH20	8	-	TP00CIT-1.P
C4	05	09	PG33TK		▲	Ph/Cry	PH20	8	-	TP00CIT-1.P
C4	10	-	PG33TK		▲	Ph/Cry	PH20	8	-	TP00CIT-1.P
C4-Picasso	06	13	PG83TK		▲	Ph/Cry	PH20	8	HU83TE	TP00HU-HCA.P
C5	01	08	CN22TK		▲	Ph/Cry	PH20	2	SIX9TE	TP00SIX-3.P3
C5	08	-	PG83TK		▲	Ph/Cry	PH20	8	HU83TE	TP00HU-HCA.P
C6	06	-	PG33TK		▲	Ph/Cry	PH20	8	-	TP00CIT-1.P
C8	02	14	PG83TK		▲	Ph/Cry	PH20	8	HU83TE	TP00HU-HCA.P
C-Crosser	07	-	MT8SBTK		▲	Ph/Cry	PH20	7	MIT11RTE	TP00MIT-8D.P2
C-Zero	11	-	MT8SBTK		▲	Ph/Cry	PH20	7	MIT11RTE	TP00MIT-8D.P2
Dispatch	02	06	CN22TK		▲	Ph/Cry	PH20	2	SIX9TE	TP00SIX-3.P3
Dispatch	07	-	PG83TK		▲	Ph/Cry	PH20	8	HU83TE	TP00HU-HCA.P
DS3	10	-	PG33TK		▲	Ph/Cry	PH20	8	-	TP00CIT-1.P
DS4	11	-	PG33TK		▲	Ph/Cry	PH20	8	-	TP00CIT-1.P
Evasion	98	02	CN22TK			Ph	PH00	2	SIX9TE	TP00SIX-3.P3
Jumper	96	01	FT50TK		●	Meg	MG00	4	GT10BTE	TP00FI-11.P5
Jumper	01	05	CN22TK		●	Meg/Cry	MG10	2	SIX9TE	TP00SIX-3.P3
Jumper	06	-	FT22TK		▲	Ph/Cry	PH20	4	SIP22TE	TP00FI16.P
Jumpy	98	-	CN22TK			Ph	PH00	2	SIX9TE	TP00SIX-3.P3
Jumpy	02	06	CN22TK		▲	Ph/Cry	PH20	2	SIX9TE	TP00SIX-3.P3
Jumpy	07	-	PG83TK		▲	Ph/Cry	PH20	8	HU83TE	TP00HU-HCA.P
Nemo	08	-	FT22TK		▲	Ph/Cry	PH20	4	SIP22TE	TP00FI16.P
Relay	96	01	FT50TK		●	Meg	MG00	4	GT10BTE	TP00FI-11.P5
Relay	01	05	CN22TK		●	Meg/Cry	MG10	2	SIX9TE	TP00SIX-3.P3
Relay	06	-	FT22TK		▲	Ph/Cry	PH20	4	SIP22TE	TP00FI16.P

MODEL	YEAR	KEYLINE REFERENCE	KEYLINE MICRO SERIES			TRANS. TYPE	ID	PAGE	CROSS REFERENCE OF SUBSTITUTE (WHERE AVAILABLE)	
			T	P	M					
CITROËN (F)										
Saxo	98	00	CN22TK			Ph	PH00	2	SIX9TE	TP00SIX-3.P3
Saxo	00	03	CN22TK	▲		Ph/Cry	PH20	2	SIX9TE	TP00SIX-3.P3
Xantia	98	99	CN22TK			Ph	PH00	2	SIX9TE	TP00SIX-3.P3
Xantia	00	01	CN22TK		●	Meg/Cry	MG10	2	SIX9TE	TP00SIX-3.P3
Xsara	97	00	CN22TK			Ph	PH00	2	SIX9TE	TP00SIX-3.P3
Xsara	01	06	CN22TK	▲		Ph/Cry	PH20	2	SIX9TE	TP00SIX-3.P3
Xsara Picasso	02	07	CN22TK	▲		Ph/Cry	PH20	2	SIX9TE	TP00SIX-3.P3
DACIA (RO)										
Symbol	10	-	RN30TK	▲		Ph/Cry	PH20	8	NE73TE	TP00NE-38.P4
DAF (D)										
CF	02	-	RN30TK		●	Meg/Cry	MG10	8	NE73TE	TP00NE-38.P4
LF	02	-	RN30TK		●	Meg/Cry	MG10	8	NE73TE	TP00NE-38.P4
XF	02	-	RN30TK		●	Meg/Cry	MG10	8	NE73TE	TP00NE-38.P4
DAEWOO (ROK)										
Leganza	97	00	DAE47TK		●	Meg	MG00	2	DWO5TE	TP00DAE-4.P1
DAIHATSU (J)										
Boon	04	08	DAI2SJTK	■		Tex	TX00	3	TPM344 (Clover)	
Boon	08	14	DAI2SJTK	■		Tex/Cry	TCXX	3	TPM344 (Clover)	
Charade	97	04	DAI1STK	■		Tex	TX00	2	-	TP07DAI-1.P1
Coo	06	10	DAI2SJTK	■		Tex	TX00	3	TPM344 (Clover)	
Coo	10	12	DAI2SJTK	■		Tex/Cry	TCXX	3	TPM344 (Clover)	
Cuore	98	06	DAI1STK	■		Tex	TX00	2	-	TP07DAI-1.P1
Feroza	95	98	DAI1STK	■		Tex	TX00	2	-	TP07DAI-1.P1
Mira	05	08	DAI2SJTK	■		Tex	TX00	3	TPM344 (Clover)	
Mira	08	12	DAI2SJTK	■		Tex/Cry	TCXX	3	TPM344 (Clover)	
Move	97	02	DAI1STK	■		Tex	TX00	2	-	TP07DAI-1.P1
Move	98	06	DAI2SJTK	■		Tex	TX00	3	TPM344 (Clover)	
Move	06	09	DAI2SJTK	■		Tex/Cry	TCXX	3	TPM344 (Clover)	
Neikid	99	04	DAI2SJTK	■		Tex	TX00	3	TPM344 (Clover)	
New Feroza	95	-	DAI1STK	■		Tex	TX00	2	-	TP07DAI-1.P1
Sirion	98	04	DAI1STK	■		Tex	TX00	2	-	TP07DAI-1.P1
Sonica	06	09	DAI2SJTK	■		Tex	TX00	3	TPM344 (Clover)	
Terios	97	05	DAI1STK	■		Tex	TX00	2	-	TP07DAI-1.P1
YRV	00	-	DAI1STK	■		Tex	TX00	2	-	TP07DAI-1.P1
DODGE (USA)										
Avenger	08	-	Y159TK - Tan	▲		Ph/Cry	PH20	12	CY24TE	TP00CHR-15.P
Caliber	07	12	Y159TK - Tan	▲		Ph/Cry	PH20	12	CY24TE	TP00CHR-15.P
Caravan	01	03	Y159TK - Grey	■		Tex/Cry	TCXX	12	CY24TE	TP00CHR-15.P
Caravan	04	07	Y159TK - Tan	▲		Ph/Cry	PH20	12	CY24TE	TP00CHR-15.P
Challenger	07	-	Y170TK	▲		Ph/Cry	PH20	12	EK3P-Y170	-
Challenger SRT8	08	-	Y170TK	▲		Ph/Cry	PH20	12	EK3P-Y170	-
Charger	06	07	Y159TK - Tan	▲		Ph/Cry	PH20	12	CY24TE	TP00CHR-15.P
Charger	08	11	Y170TK	▲		Ph/Cry	PH20	12	EK3P-Y170	-
Dakota	01	04	Y159TK - Grey	■		Tex/Cry	TCXX	12	CY24TE	TP00CHR-15.P
Dakota	05	11	Y159TK - Tan	▲		Ph/Cry	PH20	12	CY24TE	TP00CHR-15.P
Durango	01	03	Y159TK - Grey	■		Tex/Cry	TCXX	12	CY24TE	TP00CHR-15.P
Durango	05	09	Y159TK - Tan	▲		Ph/Cry	PH20	12	CY24TE	TP00CHR-15.P
Durango	11	13	Y170TK	▲		Ph/Cry	PH20	12	EK3P-Y170	-
Grand Caravan	01	03	Y159TK - Grey	■		Tex/Cry	TCXX	12	CY24TE	TP00CHR-15.P

MODEL	YEAR		KEYLINE REFERENCE	KEYLINE MICRO SERIES			TRANS. TYPE	ID	PAGE	CROSS REFERENCE OF SUBSTITUTE (WHERE AVAILABLE)	
				T	P	M					
DODGE (USA)											
Grand Caravan	04	07	Y159TK - Tan		▲		Ph/Cry	PH20	12	CY24TE	TP00CHR-15.P
Intrepid	98	04	Y159TK - Grey	■			Tex/Cry	TCXX	12	CY24TE	TP00CHR-15.P
Journey	09	11	Y170TK		▲		Ph/Cry	PH20	12	EK3P-Y170	-
Magnum	05	07	Y159TK - Tan		▲		Ph/Cry	PH20	12	CY24TE	TP00CHR-15.P
Magnum	08	10	Y170TK		▲		Ph/Cry	PH20	12	EK3P-Y170	-
Neon	00	05	Y159TK - Grey	■			Tex/Cry	TCXX	12	CY24TE	TP00CHR-15.P
Nitro	07	12	Y159TK - Tan		▲		Ph/Cry	PH20	12	CY24TE	TP00CHR-15.P
Ram 1500	02	05	Y159TK - Grey	■			Tex/Cry	TCXX	12	CY24TE	TP00CHR-15.P
Ram 1500	06	08	Y159TK - Tan		▲		Ph/Cry	PH20	12	CY24TE	TP00CHR-15.P
Ram 1500	09	-	Y170TK		▲		Ph/Cry	PH20	12	EK3P-Y170	-
Ram 2500	02	05	Y159TK - Grey	■			Tex/Cry	TCXX	12	CY24TE	TP00CHR-15.P
Ram 2500	06	09	Y159TK - Tan		▲		Ph/Cry	PH20	12	CY24TE	TP00CHR-15.P
Ram 3500	02	05	Y159TK - Grey	■			Tex/Cry	TCXX	12	CY24TE	TP00CHR-15.P
Ram 3500	06	09	Y159TK - Tan		▲		Ph/Cry	PH20	12	CY24TE	TP00CHR-15.P
Ram CC 3500	09	09	Y159TK - Tan		▲		Ph/Cry	PH20	12	CY24TE	TP00CHR-15.P
Ram CC 4500	09	09	Y159TK - Tan		▲		Ph/Cry	PH20	12	CY24TE	TP00CHR-15.P
Ram CC 5500	09	09	Y159TK - Tan		▲		Ph/Cry	PH20	12	CY24TE	TP00CHR-15.P
SRT-4	03	05	Y159TK - Grey	■			Tex/Cry	TCXX	12	CY24TE	TP00CHR-15.P
Stratus Coupe	01	05	MT11BTK	■			Tex/Cry	TC07	7	-	TP00MIT-18.P
Stratus Sedan	99	06	Y159TK - Grey	■			Tex/Cry	TCXX	12	CY24TE	TP00CHR-15.P
SX 2.0 (Canada)	03	05	Y159TK - Grey	■			Tex/Cry	TCXX	12	CY24TE	TP00CHR-15.P
FERRARI (I)											
458	09	11	FT22TK			●	Meg/Cry	MG10	4	SIP22TE	TP00FI16.P
612 Scaglietti	04	11	FT22TK			●	Meg/Cry	MG10	4	SIP22TE	TP00FI16.P
California	08	11	FT22TK			●	Meg/Cry	MG10	4	SIP22TE	TP00FI16.P
FIAT (I)											
500	07	-	FT22TK		▲		Ph/Cry	PH20	4	SIP22TE	TP00FI16.P
Albea	02	-	FT22TK			●	Meg/Cry	MG10	4	SIP22TE	TP00FI16.P
Brava	95	96	FT1505CTK			●	Meg	MG00	4	GT15RBTE	FI-13P5
Brava	97	01	FT1505CTK				Temic	TM10	4	GT15RBTE	FI-13P5
Bravo	95	96	FT1505CTK			●	Meg	MG00	4	GT15RBTE	FI-13P5
Bravo	97	01	FT1505CTK				Temic	TM10	4	GT15RBTE	FI-13P5
Bravo	07	15	FT22TK			●	Meg/Cry	MG10	4	SIP22TE	TP00FI16.P
Bravo	07	-	FT22TK		▲		Ph/Cry	PH20	4	SIP22TE	TP00FI16.P
Cinquecento	95	96	FT50TK			●	Meg	MG00	4	GT10BTE	TP00FI-11.P5
Cinquecento	97	98	FT1505CTK			●	Meg	MG00	4	GT15RBTE	FI-13P5
Coupè	95	00	FT1505CTK				Ph	PH00	4	GT15RBTE	FI-13P5
Croma	95	97	FT50TK				Ph	PH00	4	GT10BTE	TP00FI-11.P5
Doblò	00	06	FT22TK			●	Meg/Cry	MG10	4	SIP22TE	TP00FI16.P
Doblò	06	-	FT22TK		▲		Ph/Cry	PH20	4	SIP22TE	TP00FI16.P
Doblò (S. America)	06	-	FT22TK			●	Meg/Cry	MG10	4	SIP22TE	TP00FI16.P
Ducato	96	01	FT50TK			●	Meg	MG00	4	GT10BTE	TP00FI-11.P5
Ducato	02	-	FT22TK			●	Meg/Cry	MG10	4	SIP22TE	TP00FI16.P
Ducato	06	-	FT22TK		▲		Ph/Cry	PH20	4	SIP22TE	TP00FI16.P
Fiorino	95	02	FT50TK				Temic	TM10	4	GT10BTE	TP00FI-11.P5
Grande Punto	05	09	FT22TK		▲		Ph/Cry	PH20	4	SIP22TE	TP00FI16.P
Idea	03	09	FT22TK			●	Meg/Cry	MG10	4	SIP22TE	TP00FI16.P
Idea	09	-	FT22TK		▲		Ph/Cry	PH20	4	SIP22TE	TP00FI16.P
Idea (S. America)	09	-	FT22TK			●	Meg/Cry	MG10	4	SIP22TE	TP00FI16.P

MODEL	YEAR	KEYLINE REFERENCE	KEYLINE MICRO SERIES			TRANS. TYPE	ID	PAGE	CROSS REFERENCE OF SUBSTITUTE (WHERE AVAILABLE)		
			T	P	M						
FIAT (I)											
Linea	07	-	FT22TK			●	Meg/Cry	MG10	4	SIP22TE	TP00FI16.P
Marea	96	02	FT1505CTK				Temic	TM10	4	GT15RBTE	FI-13P5
Marengo	96	-	FT1505CTK			●	Meg	MG00	4	GT15RBTE	FI-13P5
Mille	05	-	FT22TK			●	Meg/Cry	MG10	4	SIP22TE	TP00FI16.P
Multipla	98	-	FT1505CTK			●	Meg/Cry	MG10	4	GT15RBTE	FI-13P5
Palio	96	01	FT1505CTK				Temic	TM10	4	GT15RBTE	FI-13P5
Palio	02	-	FT1505CTK			●	Meg/Cry	MG10	4	GT15RBTE	FI-13P5
Panda	95	02	FT50TK			●	Meg	MG00	4	GT10BTE	TP00FI-11.P5
Panda	03	-	FT22TK		▲		Ph/Cry	PH20	4	SIP22TE	TP00FI16.P
Punto	95	99	FT1505CTK			●	Meg	MG00	4	GT15RBTE	FI-13P5
Punto	00	05	FT1505CTK			●	Meg/Cry	MG10	4	GT15RBTE	FI-13P5
Punto	00	05	FT22TK			●	Meg/Cry	MG10	4	SIP22TE	TP00FI16.P
Punto	05	08	FT22TK		▲		Ph/Cry	PH20	4	SIP22TE	TP00FI16.P
Punto Evo	09	-	FT22TK		▲		Ph/Cry	PH20	4	SIP22TE	TP00FI16.P
Qubo	08	-	FT22TK		▲		Ph/Cry	PH20	4	SIP22TE	TP00FI16.P
Scudo	96	07	CN22TK				Ph	PH00	2	SIX9TE	TP00SIX-3.P3
Scudo	07	-	PG83TK		▲		Ph/Cry	PH20	8	HU83TE	TP00HU-HCA.P
Seicento	95	96	FT50TK			●	Meg	MG00	4	GT10BTE	TP00FI-11.P5
Seicento	97	00	FT1505CTK			●	Meg	MG00	4	GT15RBTE	FI-13P5
Seicento	00	-	FT1505CTK			●	Meg/Cry	MG10	4	GT15RBTE	FI-13P5
Siena	02	-	FT1505CTK			●	Meg/Cry	MG10	4	GT15RBTE	FI-13P5
Stilo	01	07	FT22TK			●	Meg/Cry	MG10	4	SIP22TE	TP00FI16.P
Stilo (S. America)	09	11	FT22TK			●	Meg/Cry	MG10	4	SIP22TE	TP00FI16.P
Tempra	95	96	FT1505CTK			●	Meg	MG00	4	GT15RBTE	FI-13P5
Ulysse	96	01	CN22TK				Ph	PH00	2	SIX9TE	TP00SIX-3.P3
Ulysse	02	11	PG83TK		▲		Ph/Cry	PH20	8	HU83TE	TP00HU-HCA.P
FORD (AUS)											
121	96	01	FD3TK	■			Tex	TX00	3	FO21TE	TP00FO-6.P
B-Series	99	01	FD21BTK	■			Tex	TX00	3	FO38RTE	TP00FO-30D.P
Escape	05	-	FD21BTK	■			Tex/Cry	TC01	3	FO38RTE	TP00FO-30D.P
Explorer	00	06	FD21BTK	■			Tex/Cry	TC01	3	FO38RTE	TP00FO-30D.P
Explorer Sport Track	98	05	FD21BTK	■			Tex/Cry	TCXX	3	FO38RTE	TP00FO-30D.P
Falcon	99	05	FD3TK	■			Tex/Cry	TC01	3	FO21TE	TP00FO-6.P
Falcon	05	-	FD40BTK	■			Tex/Cry	TP01	3	HU101TE	TP00FO-24.P
Falcon	11	-	FD40BTK	■			Tex/Cry	TP80	3	HU101TE	TP00FO-24.P
Fiesta	13	-	FD40BTK	■			Tex/Cry	TP80	3	HU101TE	TP00FO-24.P
Focus	00	04	FD21BTK	■			Tex/Cry	TC01	3	FO38RTE	TP00FO-30D.P
Focus	11	16	FD40BTK	■			Tex/Cry	TP80	3	HU101TE	TP00FO-24.P
Kuga	12	16	FD40BTK	■			Tex/Cry	TP80	3	HU101TE	TP00FO-24.P
Mondeo	10	15	FD40BTK	■			Tex/Cry	TP80	3	HU101TE	TP00FO-24.P
Ranger	11	15	FD40BTK	■			Tex/Cry	TP80	3	HU101TE	TP00FO-24.P
Taurus LX / SHO	98	99	FD21BTK	■			Tex/Cry	TCXX	3	FO38RTE	TP00FO-30D.P
Tribute	01	03	FD21BTK	■			Tex/Cry	TC01	3	FO38RTE	TP00FO-30D.P
FORD (BR)											
C-Max	04	07	FC7TK	■			Tex/Cry	TCXX	3	FO10TE	TP00FO-TX.P
Eco-Sport	03	07	FC7TK	■			Tex/Cry	TCXX	3	FO10TE	TP00FO-TX.P
Fiesta	03	-	FC7TK	■			Tex/Cry	TCXX	3	FO10TE	TP00FO-TX.P
Fiesta Max	05	-	FC7TK	■			Tex/Cry	TCXX	3	FO10TE	TP00FO-TX.P

MODEL	YEAR	KEYLINE REFERENCE	KEYLINE MICRO SERIES			TRANS. TYPE	ID	PAGE	CROSS REFERENCE OF SUBSTITUTE (WHERE AVAILABLE)	
			T	P	M					
FORD (EU)										
B-Max	12	-	FD40BTK	■		Tex/Cry	TP80	3	HU101TE	TP00FO-24.P
C-Max	03	10	FD40BTK	■		Tex/Cry	TP01	3	HU101TE	TP00FO-24.P
C-Max	11	-	FD40BTK	■		Tex/Cry	TP80	3	HU101TE	TP00FO-24.P
Cougar	97	97	FD3TK	■		Tex	TX00	3	FO21TE	TP00FO-6.P
Courier	95	-	FD3TK	■		Tex	TX00	3	FO21TE	TP00FO-6.P
EcoSport	13	-	FD40BTK	■		Tex/Cry	TP80	3	HU101TE	TP00FO-24.P
Edge	11	13	FD40BTK	■		Tex/Cry	TP80	3	HU101TE	TP00FO-24.P
Escort	95	00	FD3TK	■		Tex	TX00	3	FO21TE	TP00FO-6.P
Fiesta	95	02	FD3TK	■		Tex	TX00	3	FO21TE	TP00FO-6.P
Fiesta	03	08	FD3TK	■		Tex/Cry	TP01	3	FO21TE	TP00FO-6.P
Fiesta	13	17	VX5BTK	■		Tex/Cry	TP80	11	HU100TE	TP00OP-11.P1
Focus	98	04	FD3TK	■		Tex/Cry	TP01	3	FO21TE	TP00FO-6.P
Focus	04	10	FD40BTK	■		Tex/Cry	TP01	3	HU101TE	TP00FO-24.P
Focus	11	-	FD40BTK	■		Tex/Cry	TP80	3	HU101TE	TP00FO-24.P
Fusion	02	-	FD3TK	■		Tex/Cry	TP01	3	FO21TE	TP00FO-6.P
Galaxy	10	14	FD40BTK	■		Tex/Cry	TP80	3	HU101TE	TP00FO-24.P
Ka	96	02	FD3TK	■		Tex	TX00	3	FO21TE	TP00FO-6.P
Ka	95	02	FD3TK	■		Tex/Cry	TP01	3	FO21TE	TP00FO-6.P
Kuga	12	15	FD40BTK	■		Tex/Cry	TP80	3	HU101TE	TP00FO-24.P
Maverick	95	-	NS27TK			Ph	PH00	7	NSN11TE	TP00DAT-6.P2
Mondeo	95	00	FD3TK	■		Tex	TX00	3	FO21TE	TP00FO-6.P
Mondeo	01	07	FD3TK	■		Tex/Cry	TC01	3	FO21TE	TP00FO-6.P
Mondeo	07	-	FD40BTK	■		Tex/Cry	TCXX	3	HU101TE	TP00FO-24.P
Mondeo	11	14	FD40BTK	■		Tex/Cry	TP80	3	HU101TE	TP00FO-24.P
Puma	97	02	FD3TK	■		Tex	TX00	3	FO21TE	TP00FO-6.P
Ranger	12	-	FD40BTK	■		Tex/Cry	TP80	3	HU101TE	TP00FO-24.P
Scorpio	95	98	FD3TK	■		Tex	TX00	3	FO21TE	TP00FO-6.P
S-Max	06	-	FD40BTK	■		Tex/Cry	TP01	3	HU101TE	TP00FO-24.P
S-Max	10	14	FD40BTK	■		Tex/Cry	TP80	3	HU101TE	TP00FO-24.P
Tourneo Connect	13	-	FD40BTK	■		Tex/Cry	TP80	3	HU101TE	TP00FO-24.P
Tourneo Courier	12	-	FD40BTK	■		Tex/Cry	TP80	3	HU101TE	TP00FO-24.P
Tourneo Custom	13	-	FD40BTK	■		Tex/Cry	TP80	3	HU101TE	TP00FO-24.P
Transit	95	98	FD3TK	■		Tex	TX00	3	FO21TE	TP00FO-6.P
Transit	00	-	FD3TK	■		Tex/Cry	TCXX	3	FO21TE	TP00FO-6.P
Transit	13	-	FD40BTK	■		Tex/Cry	TP80	3	HU101TE	TP00FO-24.P
Transit Connect	13	-	FD40BTK	■		Tex/Cry	TP80	3	HU101TE	TP00FO-24.P
Transit Courier	12	-	FD40BTK	■		Tex/Cry	TP80	3	HU101TE	TP00FO-24.P
Transit Custom	12	-	FD40BTK	■		Tex/Cry	TP80	3	HU101TE	TP00FO-24.P
FORD (SOUTH AMERICA)										
EcoSport	12	-	FD40BTK	■		Tex/Cry	TP80	3	HU101TE	TP00FO-24.P
FORD (USA)										
C-Max	13	-	FD40BTK	■		Tex/Cry	TP80	3	HU101TE	TP00FO-24.P
Crown Victoria	07	11	FD21BTK	■		Tex	TX00	3	FO38RTE	TP00FO-30D.P
Edge	07	-	FD21BTK	■		Tex/Cry	TC08	3	FO38RTE	TP00FO-30D.P
Edge	11	15	FD21BTK	■		Tex/Cry	TP80	3	FO38RTE	TP00FO-30D.P
Escape	05	12	FD21BTK	■		Tex/Cry	TC01	3	FO38RTE	TP00FO-30D.P
Escape	12	-	FD40BTK	■		Tex/Cry	TP80	3	HU101TE	TP00FO-24.P
E-Series	08	-	FD21BTK	■		Tex/Cry	TC08	3	FO38RTE	TP00FO-30D.P
E-Series Van	13	-	FD21BTK	■		Tex/Cry	TP80	3	FO38RTE	TP00FO-30D.P

MODEL	YEAR	KEYLINE REFERENCE	KEYLINE MICRO SERIES			TRANS. TYPE	ID	PAGE	CROSS REFERENCE OF SUBSTITUTE (WHERE AVAILABLE)	
			T	P	M					
FORD (USA)										
Excursion	07	-	FD21BTK	■		Tex/Cry	TCXX	3	FO38RTE	TP00FO-30D.P
Expedition	07	-	FD21BTK	■		Tex	TX00	3	FO38RTE	TP00FO-30D.P
Expedition	11	17	FD21BTK	■		Tex/Cry	TP80	3	FO38RTE	TP00FO-30D.P
Explorer	07	-	FD21BTK	■		Tex	TX00	3	FO38RTE	TP00FO-30D.P
Explorer	11	15	FD21BTK	■		Tex/Cry	TP80	3	FO38RTE	TP00FO-30D.P
Explorer Sport Trac	01	05	FD21BTK	■		Tex/Cry	TCXX	3	FO38RTE	TP00FO-30D.P
F-150	04	-	FD21BTK	■		Tex	TX00	3	FO38RTE	TP00FO-30D.P
F-150	11	14	FD21BTK	■		Tex/Cry	TP80	3	FO38RTE	TP00FO-30D.P
F-250	08	-	FD21BTK	■		Tex	TX00	3	FO38RTE	TP00FO-30D.P
F-250	11	16	FD21BTK	■		Tex/Cry	TP80	3	FO38RTE	TP00FO-30D.P
F-350	08	-	FD21BTK	■		Tex/Cry	TCXX	3	FO38RTE	TP00FO-30D.P
F-350	11	16	FD21BTK	■		Tex/Cry	TP80	3	FO38RTE	TP00FO-30D.P
F-450	08	-	FD21BTK	■		Tex/Cry	TC08	3	FO38RTE	TP00FO-30D.P
F-450	11	16	FD21BTK	■		Tex/Cry	TP80	3	FO38RTE	TP00FO-30D.P
Fiesta	11	-	FD40BTK	■		Tex/Cry	TP80	3	HU101TE	TP00FO-24.P
Five Hundred	05	07	FD21BTK	■		Tex/Cry	TCXX	3	FO38RTE	TP00FO-30D.P
Flex	09	-	FD21BTK	■		Tex/Cry	TCXX	3	FO38RTE	TP00FO-30D.P
Flex	11	-	FD21BTK	■		Tex/Cry	TP80	3	FO38RTE	TP00FO-30D.P
Focus	06	11	FD21BTK	■		Tex/Cry	TC01	3	FO38RTE	TP00FO-30D.P
Focus	11	11	FD21BTK	■		Tex/Cry	TP80	3	FO38RTE	TP00FO-30D.P
Focus	12	-	FD40BTK	■		Tex/Cry	TP80	3	HU101TE	TP00FO-24.P
Freestar	04	07	FD21BTK	■		Tex/Cry	TC01	3	FO38RTE	TP00FO-30D.P
Freestyle	05	07	FD21BTK	■		Tex/Cry	TC01	3	FO38RTE	TP00FO-30D.P
Fusion	06	12	FD21BTK	■		Tex/Cry	TC08	3	FO38RTE	TP00FO-30D.P
Fusion	11	12	FD21BTK	■		Tex/Cry	TP80	3	FO38RTE	TP00FO-30D.P
Mustang	05	-	FD21BTK	■		Tex	TX00	3	FO38RTE	TP00FO-30D.P
Mustang	11	14	FD21BTK	■		Tex/Cry	TP80	3	FO38RTE	TP00FO-30D.P
Ranger	01	05	FD21BTK	■		Tex	TX00	3	FO38RTE	TP00FO-30D.P
Ranger	06	11	FD21BTK	■		Tex/Cry	TC08	3	FO38RTE	TP00FO-30D.P
Ranger	11	12	FD21BTK	■		Tex/Cry	TP80	3	FO38RTE	TP00FO-30D.P
Taurus	00	-	FD21BTK	■		Tex	TX00	3	FO38RTE	TP00FO-30D.P
Taurus	11	-	FD21BTK	■		Tex/Cry	TP80	3	FO38RTE	TP00FO-30D.P
Thunderbird	03	05	FD21BTK	■		Tex/Cry	TC01	3	FO38RTE	TP00FO-30D.P
Transit	13	-	FD40BTK	■		Tex/Cry	TP80	3	HU101TE	TP00FO-24.P
Transit Connect	14	-	FD40BTK	■		Tex/Cry	TP80	3	HU101TE	TP00FO-24.P
Windstar	95	96	FD20TK	■		Tex	TX00	3	FO26TE	TP00FO-16P
Windstar	01	03	FD21BTK	■		Tex	TX00	3	FO38RTE	TP00FO-30D.P
GILERA (I)										
Fuoco	06	-	FT22TK			Temic	TM10	4	SIP22TE	TP00FI16.P
GP800	06	-	FT22TK			Temic	TM10	4	SIP22TE	TP00FI16.P
Nexus 300	07	-	FT22TK			Temic	TM10	4	SIP22TE	TP00FI16.P
GMC (USA)										
Acadia	07	-	B106TK	▲		Ph/Cry	PH20	2	-	-
Canyon	08	12	TR47TK		●	Meg/Cry	MG10	10	TOY43TE	TP00TOYO-15.P
Denali	07	-	B106TK	▲		Ph/Cry	PH20	2	-	-
Envoy	07	-	B106TK	▲		Ph/Cry	PH20	2	-	-
Savana	08	-	B106TK	▲		Ph/Cry	PH20	2	-	-
Sierra	07	-	B106TK	▲		Ph/Cry	PH20	2	-	-
Silverado	14	15	VX6BTK	▲		Ph/Cry	PH20	12	-	-

MODEL	YEAR	KEYLINE REFERENCE	KEYLINE MICRO SERIES			TRANS. TYPE	ID	PAGE	CROSS REFERENCE OF SUBSTITUTE (WHERE AVAILABLE)	
			T	P	M					
GMC (USA)										
Yukon	07	-	B106TK		▲	Ph/Cry	PH20	2	-	-
GREAT WALL (CN)										
H3	08	-	TR47STK			● Meg/Cry	MG10	10	TOY43RATE	-
Hafu	06	-	TR47STK			● Meg/Cry	MG10	10	TOY43RATE	-
Steed	09	12	TR47STK			● Meg/Cry	MG10	10	TOY43RATE	-
V200	11	-	TR47STK			● Meg/Cry	MG10	10	TOY43RATE	-
V240	08	-	TR47STK			● Meg/Cry	MG10	10	TOY43RATE	-
X Series	06	-	TR47STK			● Meg/Cry	MG10	10	TOY43RATE	-
HOLDEN (AUS)										
Commodore	07	07	HC1TK		▲	Ph/Cry	PH20	4	-	TP00GM-49D.P
Frontera	99	-	HD90TK			● Meg/Cry	MG10	5	HON58RTE	TP00HOND-21.P
Jackaroo	99	06	TR47STK			● Meg/Cry	MG10	10	TOY43RATE	-
Rodeo	99	06	TR47STK			● Meg/Cry	MG10	10	TOY43RATE	-
HONDA (AUS)										
Civic	06	08	HD1BTK		▲	Ph/Cry	PH20	4	HON66TE	TP00HOND-31.P
MD-X	03	08	HD1BTK		▲	Ph/Cry	PH20	4	HON66TE	TP00HOND-31.P
HONDA (J)										
Accord	95	99	HD90TK			Ph	PH00	5	HON58RTE	TP00HOND-21.P
Accord	99	03	HD1BTK			● Meg/Cry	MG10	4	HON66TE	TP00HOND-31.P
Accord	03	-	HD1BTK		▲	Ph/Cry	PH20	4	HON66TE	TP00HOND-31.P
Accord	06	08	HD1BTK			● Meg/Cry	MG10	4	HON66TE	TP00HOND-31.P
City	02	07	HD90TK			● Meg/Cry	MG10	5	HON58RTE	TP00HOND-21.P
Civic	95	99	HD90TK			Ph	PH00	5	HON58RTE	TP00HOND-21.P
Civic	99	02	HD90TK			● Meg/Cry	MG10	5	HON58RTE	TP00HOND-21.P
Civic	03	05	HD1BTK			● Meg/Cry	MG10	4	HON66TE	TP00HOND-31.P
Civic	06	08	HD1BTK		▲	Ph/Cry	PH20	4	HON66TE	TP00HOND-31.P
CR-V	97	99	HD90TK			● Meg	MG00	5	HON58RTE	TP00HOND-21.P
CR-V	00	01	HD90TK			● Meg/Cry	MG10	5	HON58RTE	TP00HOND-21.P
CR-V	02	06	HD1BTK			● Meg/Cry	MG10	4	HON66TE	TP00HOND-31.P
CR-Z	10	-	HD1BTK		▲	Ph/Cry	PH20	4	HON66TE	TP00HOND-31.P
Edix	04	07	HD1BTK			● Meg/Cry	MG10	4	HON66TE	TP00HOND-31.P
Element	03	11	HD1BTK			● Meg	MG00	4	HON66TE	TP00HOND-31.P
FR-V	07	-	HD1BTK			● Meg/Cry	MG10	4	HON66TE	TP00HOND-31.P
HR-V	00	05	HD90TK			● Meg/Cry	MG10	5	HON58RTE	TP00HOND-21.P
Insight	00	05	HD90TK			● Meg/Cry	MG10	5	HON58RTE	TP00HOND-21.P
Insight	09	-	HD1BTK		▲	Ph/Cry	PH20	4	HON66TE	TP00HOND-31.P
Integra	98	01	HD90TK			● Meg	MG00	5	HON58RTE	TP00HOND-21.P
Jazz	01	07	HD1BTK			● Meg/Cry	MG10	4	HON66TE	TP00HOND-31.P
Jazz	06	-	HD1BTK			● Meg/Cry	MG10	4	HON66TE	TP00HOND-31.P
Jazz	08	-	HD1BTK		▲	Ph/Cry	PH20	4	HON66TE	TP00HOND-31.P
Legend	97	04	HD90TK			● Meg	MG00	5	HON58RTE	TP00HOND-21.P
Legend	07	-	HD1BTK			● Meg/Cry	MG10	4	HON66TE	TP00HOND-31.P
Logo	99	-	HD90TK			● Meg/Cry	MG10	5	HON58RTE	TP00HOND-21.P
NSX	97	05	HD90TK			● Meg	MG00	5	HON58RTE	TP00HOND-21.P
Odyssey	98	-	HD90TK			● Meg	MG00	5	HON58RTE	TP00HOND-21.P
Passport	98	-	HD90TK			● Meg	MG00	5	HON58RTE	TP00HOND-21.P
Pilot	03	-	HD1BTK			● Meg	MG00	4	HON66TE	TP00HOND-31.P
Prelude	95	01	HD90TK			● Meg	MG00	5	HON58RTE	TP00HOND-21.P
S2000	00	03	HD90TK			● Meg/Cry	MG10	5	HON58RTE	TP00HOND-21.P

MODEL	YEAR		KEYLINE REFERENCE	KEYLINE MICRO SERIES			TRANS. TYPE	ID	PAGE	CROSS REFERENCE OF SUBSTITUTE (WHERE AVAILABLE)	
				T	P	M					
HONDA (J)											
S2000	00	03	HD1BTK			●	Meg/Cry	MG10	4	HON66TE	TP00HOND-31.P
S2000	04	05	HD1BTK			●	Meg/Cry	MG10	4	HON66TE	TP00HOND-31.P
S2000	06	-	HD1BTK			●	Meg/Cry	MG10	4	HON66TE	TP00HOND-31.P
Shuttle	95	00	HD90TK			●	Meg	MG00	5	HON58RTE	TP00HOND-21.P
Shuttle	01	-	HD90TK			●	Meg/Cry	MG10	5	HON58RTE	TP00HOND-21.P
Stream	01	03	HD90TK			●	Meg/Cry	MG10	5	HON58RTE	TP00HOND-21.P
Stream	03	07	HD1BTK			●	Meg/Cry	MG10	4	HON66TE	TP00HOND-31.P
Stream	08	-	HD1BTK		▲		Ph/Cry	PH20	4	HON66TE	TP00HOND-31.P
HONDA (J) - Moto											
CB1000	11	-	HD70TK			▲	Ph/Cry	PH20	5	HON70TE	TP00HOND-24.P1
CBF 1000	04	-	HD70TK			▲	Ph/Cry	PH20	5	HON70TE	TP00HOND-24.P1
CBR 1000RR Fireblade	07	-	HD70TK			▲	Ph/Cry	PH20	5	HON70TE	TP00HOND-24.P1
CBR 1100F	99	-	HD70TK			▲	Ph/Cry	PH20	5	HON70TE	TP00HOND-24.P1
CBR 600F	99	-	HD70TK			▲	Ph/Cry	PH20	5	HON70TE	TP00HOND-24.P1
CBR 600RR	03	-	HD70TK			▲	Ph/Cry	PH20	5	HON70TE	TP00HOND-24.P1
CBR 900	03	-	HD70TK			▲	Ph/Cry	PH20	5	HON70TE	TP00HOND-24.P1
Crossrunner	11	-	HD70TK			▲	Ph/Cry	PH20	5	HON70TE	TP00HOND-24.P1
Crosstourer	12	-	HD70TK			▲	Ph/Cry	PH20	5	HON70TE	TP00HOND-24.P1
Hornet	03	-	HD70TK			▲	Ph/Cry	PH20	5	HON70TE	TP00HOND-24.P1
Integra	12	-	HD70TK			▲	Ph/Cry	PH20	5	HON70TE	TP00HOND-24.P1
NC700 S	12	-	HD70TK			▲	Ph/Cry	PH20	5	HON70TE	TP00HOND-24.P1
NC700 X	12	-	HD70TK			▲	Ph/Cry	PH20	5	HON70TE	TP00HOND-24.P1
NT 650V	99	-	HD70TK			▲	Ph/Cry	PH20	5	HON70TE	TP00HOND-24.P1
Shadow 750	04	-	HD70TK			▲	Ph/Cry	PH20	5	HON70TE	TP00HOND-24.P1
Shadow Spirit 750	04	-	HD70TK			▲	Ph/Cry	PH20	5	HON70TE	TP00HOND-24.P1
Silver Wing	01	08	HD70TK			▲	Ph/Cry	PH20	5	HON70TE	TP00HOND-24.P1
ST1300 PAN	08	-	HD70TK			▲	Ph/Cry	PH20	5	HON70TE	TP00HOND-24.P1
SW-T 400	09	-	HD70TK			▲	Ph/Cry	PH20	5	HON70TE	TP00HOND-24.P1
SW-T 600	11	-	HD70TK			▲	Ph/Cry	PH20	5	HON70TE	TP00HOND-24.P1
Transalp 700	08	-	HD70TK			▲	Ph/Cry	PH20	5	HON70TE	TP00HOND-24.P1
Varadero	03	-	HD70TK			▲	Ph/Cry	PH20	5	HON70TE	TP00HOND-24.P1
VFR 1200	09	-	HD70TK			▲	Ph/Cry	PH20	5	HON70TE	TP00HOND-24.P1
VT750 C4	04	10	HD70TK			▲	Ph/Cry	PH20	5	HON70TE	TP00HOND-24.P1
VTX1800	02	-	HD70TK			▲	Ph/Cry	PH20	5	HON70TE	TP00HOND-24.P1
X11	01	-	HD70TK			▲	Ph/Cry	PH20	5	HON70TE	TP00HOND-24.P1
HONDA (USA)											
Accord	98	02	HD90TK			●	Meg	MG00	5	HON58RTE	TP00HOND-21.P
Accord Crosstour	10	11	HD1BTK			▲	Ph/Cry	PH20	4	HON66TE	TP00HOND-31.P
Civic	01	02	HD90TK			●	Meg	MG00	5	HON58RTE	TP00HOND-21.P
Civic	03	11	HD1BTK			●	Meg	MG00	4	HON66TE	TP00HOND-31.P
Civic	06	-	HD1BTK			▲	Ph/Cry	PH20	4	HON66TE	TP00HOND-31.P
Crosstour	12	-	HD1BTK			▲	Ph/Cry	PH20	4	HON66TE	TP00HOND-31.P
CR-V	02	-	HD1BTK			●	Meg	MG00	4	HON66TE	TP00HOND-31.P
CR-Z	11	-	HD1BTK			▲	Ph/Cry	PH20	4	HON66TE	TP00HOND-31.P
Fit	07	-	HD1BTK			●	Meg/Cry	MG10	4	HON66TE	TP00HOND-31.P
Fit	09	-	HD1BTK			▲	Ph/Cry	PH20	4	HON66TE	TP00HOND-31.P
Insight	00	06	HD90TK			●	Meg	MG00	5	HON58RTE	TP00HOND-21.P
Insight	10	-	HD1BTK			▲	Ph/Cry	PH20	4	HON66TE	TP00HOND-31.P
Odyssey	98	02	HD90TK			●	Meg	MG00	5	HON58RTE	TP00HOND-21.P

MODEL	YEAR	KEYLINE REFERENCE	KEYLINE MICRO SERIES			TRANS. TYPE	ID	PAGE	CROSS REFERENCE OF SUBSTITUTE (WHERE AVAILABLE)		
			T	P	M						
HONDA (USA)											
Odyssey	03	-	HD1BTK			●	Meg	MG00	4	HON66TE	TP00HOND-31.P
Prelude	97	02	HD90TK			●	Meg	MG00	5	HON58RTE	TP00HOND-21.P
Ridgeline	06	-	HD1BTK			▲	Ph/Cry	PH20	4	HON66TE	TP00HOND-31.P
S2000	00	03	HD90TK			●	Meg	MG00	5	HON58RTE	TP00HOND-21.P
S2000	04	05	HD1BTK			●	Meg	MG00	4	HON66TE	TP00HOND-31.P
S2000	06	-	HD1BTK			●	Meg/Cry	MG10	4	HON66TE	TP00HOND-31.P
HUMMER (USA)											
H2	08	-	B106TK			▲	Ph/Cry	PH20	2	-	-
H2 Sut	08	-	B106TK			▲	Ph/Cry	PH20	2	-	-
H3	08	-	B106TK			▲	Ph/Cry	PH20	2	-	-
HYUNDAI (ROK)											
Accent	96	99	HY10TK	■			Tex	TX00	5	HYN10TE	TP00HY-5.P1
Atos	97	00	HY10TK	■			Tex	TX00	5	HYN10TE	TP00HY-5.P1
Atos Prime	99	01	HY10TK	■			Tex	TX00	5	HYN10TE	TP00HY-5.P1
Coupé	96	02	HY6TK	■			Tex	TX00	5	HYN6TE	TP00HY-4.P1
Creta	14	-	HY14STK	■			Tex/Cry	TP80	6	HYN14RTE	TP00HY-11D.P1
Elantra	96	00	HY6TK	■			Tex	TX00	5	HYN6TE	TP00HY-4.P1
Elantra	07	-	HY14STK			▲	Ph/Cry	PH20	6	HYN14RTE	TP00HY-11D.P1
Entourage	07	09	HY14TK			▲	Ph/Cry	PH20	6	HYN14TE	TP00HY-11.P1
Eon (India)	10	-	HY14STK	■			Tex/Cry	TP80	6	HYN14RTE	TP00HY-11D.P1
Excel	96	99	HY10TK	■			Tex	TX00	5	HYN10TE	TP00HY-5.P1
Galloper	99	03	HY6TK	■			Tex	TX00	5	HYN6TE	TP00HY-4.P1
H-1	99	-	HY6TK	■			Tex	TX00	5	HYN6TE	TP00HY-4.P1
H-1 Bus	08	-	HY14TK			▲	Ph/Cry	PH20	6	HYN14TE	TP00HY-11.P1
HB20 (Brazil)	12	-	HY14STK	■			Tex/Cry	TP80	6	HYN14RTE	TP00HY-11D.P1
i10	08	-	HY14TK			▲	Ph/Cry	PH20	6	HYN14TE	TP00HY-11.P1
Lantra	96	00	HY6TK	■			Tex	TX00	5	HYN6TE	TP00HY-4.P1
Santa Fe	06	-	HY14STK			▲	Ph/Cry	PH20	6	HYN14RTE	TP00HY-11D.P1
Santa Fe	13	-	HY21STK	■			Tex/Cry	TP80	6	HYN17RBTE	-
Santa Fe (Canada)	07	09	HY14STK			▲	Ph/Cry	PH20	6	HYN14RTE	TP00HY-11D.P1
Santamo	99	03	HY6TK	■			Tex	TX00	5	HYN6TE	TP00HY-4.P1
Scoupe	96	-	HY6TK	■			Tex	TX00	5	HYN6TE	TP00HY-4.P1
Sonata	96	98	HY7STK	■			Tex	TX00	5	HYN7RTE	TP00HY-6D.P1
Sonata	05	-	HY14STK			▲	Ph/Cry	PH20	6	HYN14RTE	TP00HY-11D.P1
Sonata (Canada)	08	10	HY14STK			▲	Ph/Cry	PH20	6	HYN14RTE	TP00HY-11D.P1
Starex	98	-	HY12TK	■			Tex	TX00	5	HYN12TE	TP00HY-9.P
Varacruz (Canada)	07	11	HY14STK			▲	Ph/Cry	PH20	6	HYN14RTE	TP00HY-11D.P1
Veloster	10	-	HY21TK	■			Tex/Cry	TP80	6	HYN17BTE	TP00HY-19D.P1
Veracruz	07	-	HY14STK			▲	Ph/Cry	PH20	6	HYN14RTE	TP00HY-11D.P1
HYUNDAI (USA)											
Accent	12	-	HY21TK			▲	Ph/Cry	PH20	6	HYN17BTE	TP00HY-19D.P1
Elantra	96	00	HY6TK	■			Tex	TX00	5	HYN6TE	TP00HY-4.P1
Elantra GT (Canada)	13	17	HY21TK	■			Tex/Cry	TP80	6	HYN17BTE	TP00HY-19D.P1
Santa Fe	13	-	HY21STK			▲	Ph/Cry	PH20	6	HYN17RBTE	-
Velostar	12	-	HY21TK			▲	Ph/Cry	PH20	6	HYN17BTE	TP00HY-19D.P1
INFINITI (J)											
FX35	03	08	NS34BTK			▲	Ph/Cry	PH20	8	NSN14TE	TP00DAT-15.P3
FX45	03	08	NS34BTK			▲	Ph/Cry	PH20	8	NSN14TE	TP00DAT-15.P3
G20	00	02	NS34BTK	■			Tex/Cry	TCXX	8	NSN14TE	TP00DAT-15.P3

MODEL	YEAR		KEYLINE REFERENCE	KEYLINE MICRO SERIES			TRANS. TYPE	ID	PAGE	CROSS REFERENCE OF SUBSTITUTE (WHERE AVAILABLE)	
				T	P	M					
INFINITI (J)											
G35 / G35 Coupè	03	07	NS34BTK		▲		Ph/Cry	PH20	8	NSN14TE	TP00DAT-15.P3
i30	95	99	NS27TK				Ph	PH00	7	NSN11TE	TP00DAT-6.P2
M35	03	06	NS34BTK		▲		Ph/Cry	PH20	8	NSN14TE	TP00DAT-15.P3
M45	03	06	NS34BTK		▲		Ph/Cry	PH20	8	NSN14TE	TP00DAT-15.P3
Q45	95	05	NS34BTK				Ph	PH00	8	NSN14TE	TP00DAT-15.P3
QX4	95	99	NS34BTK				Ph	PH00	8	NSN14TE	TP00DAT-15.P3
QX56	04	07	NS34BTK		▲		Ph/Cry	PH20	8	NSN14TE	TP00DAT-15.P3
QXA	99	03	NS34BTK	■			Tex/Cry	TCXX	8	NSN14TE	TP00DAT-15.P3
INFINITI (USA)											
FX35	03	08	NS34BTK	■			Tex/Cry	TCXX	8	NSN14TE	TP00DAT-15.P3
FX45	03	08	NS34BTK		▲		Ph/Cry	PH20	8	NSN14TE	TP00DAT-15.P3
G20	00	02	NS34BTK	■			Tex/Cry	TCXX	8	NSN14TE	TP00DAT-15.P3
G35	03	07	NS34BTK			●	Meg/Cry	MG10	8	NSN14TE	TP00DAT-15.P3
G35 / G35 Coupè	03	07	NS34BTK		▲		Ph/Cry	PH20	8	NSN14TE	TP00DAT-15.P3
I30	00	01	NS34BTK	■			Tex/Cry	TCXX	8	NSN14TE	TP00DAT-15.P3
I35	02	04	NS34BTK	■			Tex/Cry	TCXX	8	NSN14TE	TP00DAT-15.P3
QX4	99	03	NS34BTK	■			Tex/Cry	TCXX	8	NSN14TE	TP00DAT-15.P3
QX56	04	07	NS34BTK		▲		Ph/Cry	PH20	8	NSN14TE	TP00DAT-15.P3
QY5	97	01	NS34BTK	■			Tex/Cry	TCXX	8	NSN14TE	TP00DAT-15.P3
ISUZU (J)											
700P	07	-	ISU5TK		▲		Ph/Cry	PH20	6	-	TP00ISU-5.P3
Ascender	03	-	HD90TK			●	Meg/Cry	MG10	5	HON58RTE	TP00HOND-21.P
Axiom	03	06	HD90TK			●	Meg/Cry	MG10	5	HON58RTE	TP00HOND-21.P
Big Horn	98	02	SU15TK	■			Tex/Cry	TCXX	8	SZ12TE	TP00SUZU-10P
D-Max	99	06	HD90TK			●	Meg/Cry	MG10	5	HON58RTE	TP00HOND-21.P
D-Max	07	-	TR47STK		▲		Ph/Cry	PH20	10	TOY43RATE	-
ELF	07	-	ISU5TK		▲		Ph/Cry	PH20	6	-	TP00ISU-5.P3
i-280 / i-350	06	-	HD90TK			●	Meg/Cry	MG10	5	HON58RTE	TP00HOND-21.P
i-290 / i-370	07	-	HD90TK			●	Meg/Cry	MG10	5	HON58RTE	TP00HOND-21.P
KB240	07	-	TR47TK			●	Meg/Cry	MG10	10	TOY43TE	TP00TOYO-15.P
KB240	07	-	TR47STK			●	Meg/Cry	MG10	10	TOY43RATE	-
KB300	07	-	TR47TK			●	Meg/Cry	MG10	10	TOY43TE	TP00TOYO-15.P
KB300	07	-	TR47STK			●	Meg/Cry	MG10	10	TOY43RATE	-
NPR	07	-	ISU5TK		▲		Ph/Cry	PH20	6	-	TP00ISU-5.P3
Rodeo	99	06	HD90TK			●	Meg/Cry	MG10	5	HON58RTE	TP00HOND-21.P
Trooper	98	02	SU15TK	■			Tex/Cry	TCXX	8	SZ12TE	TP00SUZU-10P
IVECO (I)											
Daily	06	-	FT50TK			●	Meg/Cry	MG10	4	GT10BTE	TP00FI-11.P5
Eurocargo	02	07	FT22TK		▲		Ph/Cry	PH20	4	SIP22TE	TP00FI16.P
Eurocargo	08	-	FT22TK	■			Tex/Cry	TCXX	4	SIP22TE	TP00FI16.P
Stralis	02	07	FT22TK		▲		Ph/Cry	PH20	4	SIP22TE	TP00FI16.P
Stralis	08	-	FT22TK	■			Tex/Cry	TCXX	4	SIP22TE	TP00FI16.P
JAGUAR (GB)											
S-Type	99	08	FD3TK	■			Tex/Cry	TC01	3	FO21TE	TP00FO-6.P
X-Type	01	09	FD3TK	■			Tex/Cry	TC01	3	FO21TE	TP00FO-6.P
JEEP (USA)											
Cherokee	98	01	Y159TK - Grey	■			Tex/Cry	TCXX	12	CY24TE	TP00CHR-15.P
Commander	06	07	Y159TK - Tan		▲		Ph/Cry	PH20	12	CY24TE	TP00CHR-15.P
Commander	08	10	Y170TK		▲		Ph/Cry	PH20	12	EK3P-Y170	-

MODEL	YEAR	KEYLINE REFERENCE	KEYLINE MICRO SERIES			TRANS. TYPE	ID	PAGE	CROSS REFERENCE OF SUBSTITUTE (WHERE AVAILABLE)	
			T	P	M					
JEEP (USA)										
Compass	07	-	Y159TK - Tan		▲	Ph/Cry	PH20	12	CY24TE	TP00CHR-15.P
Grand Cherokee	98	04	Y159TK - Grey	■		Tex/Cry	TCXX	12	CY24TE	TP00CHR-15.P
Grand Cherokee	05	07	Y159TK - Tan		▲	Ph/Cry	PH20	12	CY24TE	TP00CHR-15.P
Grand Cherokee	08	-	Y170TK		▲	Ph/Cry	PH20	12	EK3P-Y170	-
Liberty	02	04	Y159TK - Grey	■		Tex/Cry	TCXX	12	CY24TE	TP00CHR-15.P
Liberty	05	-	Y159TK - Tan		▲	Ph/Cry	PH20	12	CY24TE	TP00CHR-15.P
Patriot	07	-	Y159TK - Tan		▲	Ph/Cry	PH20	12	CY24TE	TP00CHR-15.P
Wrangler	98	06	Y159TK - Grey	■		Tex/Cry	TCXX	12	CY24TE	TP00CHR-15.P
Wrangler	07	-	Y159TK - Tan		▲	Ph/Cry	PH20	12	CY24TE	TP00CHR-15.P
KIA (ROK)										
Carens	00	06	KI3STK		▲	Ph/Cry	PH20	6	KIA3RTE	TP05KI-2D.P
Carens	01	06	KI3STK	■		Tex/Cry	TCXX	6	KIA3RTE	TP05KI-2D.P
Carens	06	-	HY14TK		▲	Ph/Cry	PH20	6	HYN14TE	TP00HY-11.P1
Carnival	99	00	KI3STK		●	Meg/Cry	MG10	6	KIA3RTE	TP05KI-2D.P
Carnival	00	02	KI3STK	■		Tex/Cry	TCXX	6	KIA3RTE	TP05KI-2D.P
Carnival	02	05	KI3STK		▲	Ph/Cry	PH20	6	KIA3RTE	TP05KI-2D.P
Carnival	05	-	HY14TK		▲	Ph/Cry	PH20	6	HYN14TE	TP00HY-11.P1
Carnival	14	-	HY14STK	■		Tex/Cry	TP80	6	HYN14RTE	TP00HY-11D.P1
Cerato	13	-	HY14STK	■		Tex/Cry	TP80	6	HYN14RTE	TP00HY-11D.P1
Clarence	00	05	KI3STK	■		Tex/Cry	TC03	6	KIA3RTE	TP05KI-2D.P
Clarus	98	01	KI3STK		●	Meg/Cry	MG10	6	KIA3RTE	TP05KI-2D.P
Forte	08	11	HY14STK		▲	Ph/Cry	PH20	6	HYN14RTE	TP00HY-11D.P1
Forte (Canada)	14	-	HY14STK	■		Tex/Cry	TP80	6	HYN14RTE	TP00HY-11D.P1
Joice	00	04	KI3STK	■		Tex/Cry	TC03	6	KIA3RTE	TP05KI-2D.P
Magentis	01	06	KI3STK		▲	Ph/Cry	PH20	6	KIA3RTE	TP05KI-2D.P
Magentis	06	-	HY14STK		▲	Ph/Cry	PH20	6	HYN14RTE	TP00HY-11D.P1
Mentor	02	04	KI3STK		▲	Ph/Cry	PH20	6	KIA3RTE	TP05KI-2D.P
Morning	11	-	HY21TK	■		Tex/Cry	TP80	6	HYN17BTE	TP00HY-19D.P1
Optima	01	06	KI3STK		▲	Ph/Cry	PH20	6	KIA3RTE	TP05KI-2D.P
Optima	07	-	HY14TK		▲	Ph/Cry	PH20	6	HYN14TE	TP00HY-11.P1
Picanto	11	-	HY21TK	■		Tex/Cry	TP80	6	HYN17BTE	TP00HY-19D.P1
Pride	99	01	KI3STK		●	Meg/Cry	MG10	6	KIA3RTE	TP05KI-2D.P
Retona	98	03	KI3STK		●	Meg/Cry	MG10	6	KIA3RTE	TP05KI-2D.P
Rio	01	05	KI3STK	■		Tex/Cry	TC03	6	KIA3RTE	TP05KI-2D.P
Rio	06	-	HY14TK		▲	Ph/Cry	PH20	6	HYN14TE	TP00HY-11.P1
Sedona	99	00	KI3STK		●	Meg/Cry	MG10	6	KIA3RTE	TP05KI-2D.P
Sedona	02	05	KI3STK		▲	Ph/Cry	PH20	6	KIA3RTE	TP05KI-2D.P
Sedona	05	-	HY14TK		▲	Ph/Cry	PH20	6	HYN14TE	TP00HY-11.P1
Sedona (Canada)	06	09	HY14STK		▲	Ph/Cry	PH20	6	HYN14RTE	TP00HY-11D.P1
Sephia	97	03	KI3STK		●	Meg/Cry	MG10	6	KIA3RTE	TP05KI-2D.P
Sephia	02	04	KI3STK		▲	Ph/Cry	PH20	6	KIA3RTE	TP05KI-2D.P
Shuma	98	01	KI3STK		●	Meg/Cry	MG10	6	KIA3RTE	TP05KI-2D.P
Shuma	00	01	KI3STK	■		Tex/Cry	TCXX	6	KIA3RTE	TP05KI-2D.P
Sorento	15	-	HY21STK	■		Tex/Cry	TP80	6	HYN17RBTE	-
Soul	09	-	HY14STK		▲	Ph/Cry	PH20	6	HYN14RTE	TP00HY-11D.P1
Sportage	99	01	KI3STK		●	Meg/Cry	MG10	6	KIA3RTE	TP05KI-2D.P
Sportage	01	05	KI3STK	■		Tex/Cry	TC03	6	KIA3RTE	TP05KI-2D.P
LAMBORGHINI (I)										
Gallardo	03	13	V66TK		●	Meg/Cry	MG10	11	HU66TE	TP00HU-HAA.P

MODEL	YEAR		KEYLINE REFERENCE	KEYLINE MICRO SERIES			TRANS. TYPE	ID	PAGE	CROSS REFERENCE OF SUBSTITUTE (WHERE AVAILABLE)	
				T	P	M					
LAMBORGHINI (I)											
Murcielago	-	10	V66TK			●	Meg/Cry	MG10	11	HU66TE	TP00HU-HAA.P
LANCIA (I)											
Delta	08	14	FT22TK			●	Meg/Cry	MG10	4	SIP22TE	TP00FI16.P
Lybra	99	-	FT22TK			●	Meg/Cry	MG10	4	SIP22TE	TP00FI16.P
Musa	04	09	FT22TK			●	Meg/Cry	MG10	4	SIP22TE	TP00FI16.P
Thesis	98	-	FT22TK			●	Meg/Cry	MG10	4	SIP22TE	TP00FI16.P
Y	03	10	FT22TK			●	Meg/Cry	MG10	4	SIP22TE	TP00FI16.P
Z	98	-	CN22TK				Ph	PH00	2	SIX9TE	TP00SIX-3.P3
LEXUS (J)											
CT200H	11	-	TR49TK			●	Meg/Cry	MG10	10	TOY40BTE	-
ES 300-330	97	03	TR49TK	■			Tex	TX00	10	TOY40BTE	-
GS series	97	03	TR49TK	■			Tex	TX00	10	TOY40BTE	-
GS series	97	03	TR48TK	■			Tex	TX00	10	TOY48BTE	TP00TOYO-36.P
HS 250H	09	-	TR49TK			●	Meg/Cry	MG10	10	TOY40BTE	-
IS series	99	03	TR48TK	■			Tex	TX00	10	TOY48BTE	TP00TOYO-36.P
LS series	97	03	TR49TK	■			Tex	TX00	10	TOY40BTE	-
LS series	97	03	TR48TK	■			Tex	TX00	10	TOY48BTE	TP00TOYO-36.P
LX series	97	03	TR49TK	■			Tex	TX00	10	TOY40BTE	-
RX 450H	10	-	TR49TK			●	Meg/Cry	MG10	10	TOY40BTE	-
RX series	98	03	TR48TK	■			Tex	TX00	10	TOY48BTE	TP00TOYO-36.P
SC series	97	03	TR49TK	■			Tex	TX00	10	TOY40BTE	-
LINCOLN (USA)											
Aviator	03	05	FD21BTK	■			Tex/Cry	TC01	3	FO38RTE	TP00FO-30D.P
LS	03	06	FD21BTK	■			Tex/Cry	TC01	3	FO38RTE	TP00FO-30D.P
Mark LT	06	08	FD21BTK	■			Tex/Cry	TC01	3	FO38RTE	TP00FO-30D.P
Mark LT	11	14	FD21BTK	■			Tex/Cry	TP80	3	FO38RTE	TP00FO-30D.P
MKT	10	11	FD21BTK	■			Tex/Cry	TP80	3	FO38RTE	TP00FO-30D.P
MKX	07	10	FD21BTK	■			Tex/Cry	TC08	3	FO38RTE	TP00FO-30D.P
MKX	11	13	FD21BTK	■			Tex/Cry	TP80	3	FO38RTE	TP00FO-30D.P
MKZ	07	12	FD21BTK	■			Tex/Cry	TC08	3	FO38RTE	TP00FO-30D.P
MKZ	11	17	FD21BTK	■			Tex/Cry	TP80	3	FO38RTE	TP00FO-30D.P
Navigator	03	-	FD21BTK	■			Tex	TX00	3	FO38RTE	TP00FO-30D.P
Navigator	09	17	FD21BTK	■			Tex/Cry	TP80	3	FO38RTE	TP00FO-30D.P
Town Car	03	11	FD21BTK	■			Tex/Cry	TC01	3	FO38RTE	TP00FO-30D.P
Zephyr	06	06	FD21BTK	■			Tex/Cry	TC08	3	FO38RTE	TP00FO-30D.P
MARUTI SUZUKI											
Alto	07	10	SU17STK	■			Tex/Cry	TCXX	9	SZ11TE	TP00SUZU-8IP1
Alto K10	10	-	SU19TK			▲	Ph/Cry	PH20	9	HU133RTE	TP00SUZU-14.P2
A-Star	07	-	SU19TK			▲	Ph/Cry	PH20	9	HU133RTE	TP00SUZU-14.P2
Ritz	07	-	SU19TK			▲	Ph/Cry	PH20	9	HU133RTE	TP00SUZU-14.P2
Swift	07	-	SU19TK			▲	Ph/Cry	PH20	9	HU133RTE	TP00SUZU-14.P2
SX4	07	-	SU19TK			▲	Ph/Cry	PH20	9	HU133RTE	TP00SUZU-14.P2
Versa	07	10	SU17TK	■			Tex/Cry	TCXX	9	SZ11RTE	TP00SUZU-8.P1
Wagon R	07	10	SU17TK	■			Tex/Cry	TCXX	9	SZ11RTE	TP00SUZU-8.P1
Wagon R	10	-	SU19TK			▲	Ph/Cry	PH20	9	HU133RTE	TP00SUZU-14.P2
Zen Estilo	07	10	SU17TK	■			Tex/Cry	TCXX	9	SZ11RTE	TP00SUZU-8.P1
MASERATI (I)											
GranSport	04	07	FT22TK			●	Meg/Cry	MG10	4	SIP22TE	TP00FI16.P
GranTurismo	07	12	FT22TK			●	Meg/Cry	MG10	4	SIP22TE	TP00FI16.P

MODEL	YEAR		KEYLINE REFERENCE	KEYLINE MICRO SERIES			TRANS. TYPE	ID	PAGE	CROSS REFERENCE OF SUBSTITUTE (WHERE AVAILABLE)	
				T	P	M					
MASERATI (I)											
Quattroporte	03	12	FT22TK			●	Meg/Cry	MG10	4	SIP22TE	TP00FI16.P
MAZDA (EU)											
121	97	-	FD3TK	■			Tex	TX00	3	FO21TE	TP00FO-6.P
323	98	00	MZ24TK				Temic	TM20	7	MAZ24RTE	TP00MAZ-11D.P2
626 (ES, LS, LUX)	98	99	MZ24TK				Ph	PH00	7	MAZ24RTE	TP00MAZ-11D.P2
B Series P/U	01	06	FD21BTK	■			Tex/Cry	TC01	3	FO38RTE	TP00FO-30D.P
BT-50	11	-	FD40BTK	■			Tex/Cry	TP80	3	HU101TE	TP00FO-24.P
Mazda 2	02	06	MZ24TK	■			Tex/Cry	TC08	7	MAZ24RTE	TP00MAZ-11D.P2
Mazda 3	03	09	MZ24TK	■			Tex/Cry	TC08	7	MAZ24RTE	TP00MAZ-11D.P2
Mazda 5	05	11	MZ24TK	■			Tex/Cry	TC08	7	MAZ24RTE	TP00MAZ-11D.P2
Mazda 6	02	07	MZ24TK	■			Tex/Cry	TC08	7	MAZ24RTE	TP00MAZ-11D.P2
MX-5	98	00	MZ24TK				Ph	PH00	7	MAZ24RTE	TP00MAZ-11D.P2
Pickup	99	01	FD21BTK	■			Tex	TX00	3	FO38RTE	TP00FO-30D.P
RX-8	04	-	MZ24TK	■			Tex/Cry	TC08	7	MAZ24RTE	TP00MAZ-11D.P2
Tribute	01	-	FD21BTK	■			Tex/Cry	TC08	3	FO38RTE	TP00FO-30D.P
MAZDA (USA)											
Series P/U	01	05	FD21BTK	■			Tex/Cry	TC01	3	FO38RTE	TP00FO-30D.P
Series P/U	06	08	FD21BTK	■			Tex/Cry	TC01	3	FO38RTE	TP00FO-30D.P
Series P/U (Canada)	10	-	FD21BTK	■			Tex/Cry	TC01	3	FO38RTE	TP00FO-30D.P
Tribute	05	11	FD21BTK	■			Tex/Cry	TC08	3	FO38RTE	TP00FO-30D.P
MERCURY (USA)											
Cougar	99	02	FD20TK	■			Tex	TX00	3	FO26TE	TP00FO-16P
Grand Marquis	03	11	FD21BTK	■			Tex	TX00	3	FO38RTE	TP00FO-30D.P
Marauder	03	04	FD21BTK	■			Tex/Cry	TC01	3	FO38RTE	TP00FO-30D.P
Mariner	07	11	FD21BTK	■			Tex/Cry	TC08	3	FO38RTE	TP00FO-30D.P
Milan	06	11	FD21BTK	■			Tex/Cry	TC08	3	FO38RTE	TP00FO-30D.P
Mystique	97	00	FD20TK	■			Tex	TX00	3	FO26TE	TP00FO-16P
Montego	05	07	FD21BTK	■			Tex/Cry	TC01	3	FO38RTE	TP00FO-30D.P
Monterey	04	07	FD21BTK	■			Tex/Cry	TC01	3	FO38RTE	TP00FO-30D.P
Mountaineer	00	10	FD21BTK	■			Tex	TX00	3	FO38RTE	TP00FO-30D.P
Sable	00	09	FD21BTK	■			Tex	TX00	3	FO38RTE	TP00FO-30D.P
MITSUBISHI (J)											
380	06	-	MT8SBTK			▲	Ph/Cry	PH20	7	MIT11RTE	TP00MIT-8D.P2
ASX	10	-	MT8SBTK			▲	Ph/Cry	PH20	7	MIT11RTE	TP00MIT-8D.P2
Colt	96	03	MT8SBTK	■			Tex	TX00	7	MIT11RTE	TP00MIT-8D.P2
Colt	04	-	MT15TK			▲	Ph/Cry	PH20	7	HU56RTE	-
Diamante	96	00	MT8SBTK	■			Tex	TX00	7	MIT11RTE	TP00MIT-8D.P2
Eclipse	96	00	MT1BTK				Temic	TM20	7	MIT8TE	TP00MIT-12.P
Eclipse	00	01	MT11BTK	■			Tex/Cry	TC07	7	-	TP00MIT-18.P
Focus	96	-	MT1BTK				Ph	PH00	7	MIT8TE	TP00MIT-12.P
Galant	96	00	MT1BTK				Ph	PH00	7	MIT8TE	TP00MIT-12.P
Galant	00	01	MT11BTK	■			Tex/Cry	TC07	7	-	TP00MIT-18.P
Grandis	03	-	MT8SBTK			▲	Ph/Cry	PH20	7	MIT11RTE	TP00MIT-8D.P2
I-MiEV	10	-	MT8SBTK			▲	Ph/Cry	PH20	7	MIT11RTE	TP00MIT-8D.P2
Lancer	96	-	MT8SBTK	■			Tex	TX00	7	MIT11RTE	TP00MIT-8D.P2
Mirage	96	02	MT8SBTK	■			Tex/Cry	TCXX	7	MIT11RTE	TP00MIT-8D.P2
Outlander	04	-	MT8SBTK	■			Tex/Cry	TCXX	7	MIT11RTE	TP00MIT-8D.P2
Pajero	96	00	MT1BTK				Ph	PH00	7	MIT8TE	TP00MIT-12.P
Pajero IO	99	-	MT8SBTK	■			Tex/Cry	TP02	7	MIT11RTE	TP00MIT-8D.P2

MODEL	YEAR	KEYLINE REFERENCE	KEYLINE MICRO SERIES			TRANS. TYPE	ID	PAGE	CROSS REFERENCE OF SUBSTITUTE (WHERE AVAILABLE)	
			T	P	M					
MITSUBISHI (J)										
Pajero Mini (J)	99	-	MT8SBTK	■		Tex/Cry	TP02	7	MIT11RTE	TP00MIT-8D.P2
Pajero Pinin	99	-	MT8SBTK	■		Tex/Cry	TP02	7	MIT11RTE	TP00MIT-8D.P2
Raider	06	09	MT11BTK	■		Tex/Cry	TC07	7	-	TP00MIT-18.P
Shogun Pinin	99	-	MT8SBTK	■		Tex/Cry	TCXX	7	MIT11RTE	TP00MIT-8D.P2
Space Gear	96	-	MT1BTK			Ph	PH00	7	MIT8TE	TP00MIT-12.P
Space Runner	96	99	MT1BTK			Ph	PH00	7	MIT8TE	TP00MIT-12.P
Verada	02	03	MT11BTK	■		Tex/Cry	TC07	7	-	TP00MIT-18.P
MITSUBISHI (USA)										
Eclipse	00	05	MT11BTK	■		Tex/Cry	TCXX	7	-	TP00MIT-18.P
Eclipse	07	12	MT8SBTK		▲	Ph/Cry	PH20	7	MIT11RTE	TP00MIT-8D.P2
Endeavor	06	07	MT11BTK		▲	Ph/Cry	PH20	7	-	TP00MIT-18.P
Endeavor	07	11	MT8SBTK		▲	Ph/Cry	PH20	7	MIT11RTE	TP00MIT-8D.P2
Galant	00	07	MT11BTK	■		Tex/Cry	TCXX	7	-	TP00MIT-18.P
Galant	06	-	MT8SBTK		▲	Ph/Cry	PH20	7	MIT11RTE	TP00MIT-8D.P2
Lancer	03	12	MT8SBTK	■		Tex/Cry	TCXX	7	MIT11RTE	TP00MIT-8D.P2
Raider	06	09	Y159TK - Tan		▲	Ph/Cry	PH20	12	CY24TE	TP00CHR-15.P
NISSAN (J)										
350-Z	03	09	MT11BTK	■		Tex/Cry	TC07	7	-	TP00MIT-18.P
Ad Expart	06	-	NS34JTK		▲	Ph/Cry	PH20	8	TPM383 (Clover)	
Almera	95	98	NS27TK			Ph	PH00	7	NSN11TE	TP00DAT-6.P2
Almera	99	-	NS34BTK		▲	Ph/Cry	PH1B	8	NSN14TE	TP00DAT-15.P3
Almera	00	-	MT11BTK	■		Tex/Cry	TC07	7	-	TP00MIT-18.P
Almera Tino	99	06	MT11BTK	■		Tex/Cry	TC07	7	-	TP00MIT-18.P
Altima	00	06	MT11BTK	■		Tex/Cry	TC07	7	-	TP00MIT-18.P
Armada (USA)	08	-	NS34BTK		▲	Ph/Cry	PH20	8	NSN14TE	TP00DAT-15.P3
Atleon	02	-	NS27TK	■		Tex/Cry	TC07	7	NSN11TE	TP00DAT-6.P2
Cab Star	00	-	NS27TK	■		Tex/Cry	TC07	7	NSN11TE	TP00DAT-6.P2
Cube	06	09	NS34JTK		▲	Ph/Cry	PH20	8	TPM383 (Clover)	
Cube (USA)	09	-	NS34BTK		▲	Ph/Cry	PH20	8	NSN14TE	TP00DAT-15.P3
Dualis	07	14	NS34JTK		▲	Ph/Cry	PH20	8	TPM383 (Clover)	
Elgrand	04	14	NS34JTK		▲	Ph/Cry	PH20	8	TPM383 (Clover)	
Frontier (USA)	02	08	MT11BTK	■		Tex/Cry	TC07	7	-	TP00MIT-18.P
Interstar	02	03	RN30TK			Ph	PH00	8	NE73TE	TP00NE-38.P4
Interstar	02	-	RN30TK		▲	Ph/Cry	PH20	8	NE73TE	TP00NE-38.P4
Juke	10	-	NS34BTK		▲	Ph/Cry	PH20	8	NSN14TE	TP00DAT-15.P3
Lafesta	06	12	NS34JTK		▲	Ph/Cry	PH20	8	TPM383 (Clover)	
Latio	08	12	NS34JTK		▲	Ph/Cry	PH20	8	TPM383 (Clover)	
Lavina	07	-	NS34BTK		▲	Ph/Cry	PH20	8	NSN14TE	TP00DAT-15.P3
March	10	-	NS34JTK		▲	Ph/Cry	PH20	8	TPM383 (Clover)	
Maxima	95	99	NS27TK			Ph	PH00	7	NSN11TE	TP00DAT-6.P2
Maxima	00	03	NS27TK	■		Tex/Cry	TC07	7	NSN11TE	TP00DAT-6.P2
Maxima	00	03	NS27TK		▲	Ph/Cry	PH1B	7	NSN11TE	TP00DAT-6.P2
Maxima	00	03	MT11BTK	■		Tex/Cry	TC07	7	-	TP00MIT-18.P
Maxima (USA)	00	07	MT11BTK	■		Tex/Cry	TC07	7	-	TP00MIT-18.P
Micra	96	98	NS27TK			Ph	PH00	7	NSN11TE	TP00DAT-6.P2
Micra	99	00	NS27TK		▲	Ph/Cry	PH1B	7	NSN11TE	TP00DAT-6.P2
Micra	01	03	NS27TK	■		Tex/Cry	TC07	7	NSN11TE	TP00DAT-6.P2
Micra	07	-	NS34BTK		▲	Ph/Cry	PH20	8	NSN14TE	TP00DAT-15.P3
Moco	06	13	NS34JTK		▲	Ph/Cry	PH20	8	TPM383 (Clover)	

MODEL	YEAR		KEYLINE REFERENCE	KEYLINE MICRO SERIES			TRANS. TYPE	ID	PAGE	CROSS REFERENCE OF SUBSTITUTE (WHERE AVAILABLE)	
				T	P	M					
NISSAN (J)											
Murano	04	11	NS34JTK		▲		Ph/Cry	PH20	8	TPM383 (Clover)	
Navara	03	-	MT11BTK	■			Tex/Cry	TC07	7	-	TP00MIT-18.P
Navara DC	05	-	NS34BTK		▲		Ph/Cry	PH20	8	NSN14TE	TP00DAT-15.P3
Note	06	-	NS34BTK		▲		Ph/Cry	PH20	8	NSN14TE	TP00DAT-15.P3
Note	08	12	NS34JTK		▲		Ph/Cry	PH20	8	TPM383 (Clover)	
NP300	10	-	NS34BTK		▲		Ph/Cry	PH20	8	NSN14TE	TP00DAT-15.P3
NV Series	12	-	NS34BTK		▲		Ph/Cry	PH20	8	NSN14TE	TP00DAT-15.P3
Patrol	98	-	NS34BTK		▲		Ph/Cry	PH1B	8	NSN14TE	TP00DAT-15.P3
Presage	04	09	NS34JTK		▲		Ph/Cry	PH20	8	TPM383 (Clover)	
Primastar	03	-	RN30TK		▲		Ph/Cry	PH20	8	NE73TE	TP00NE-38.P4
Primera	95	96	NS27TK				Ph	PH00	7	NSN11TE	TP00DAT-6.P2
Primera	97	-	NS34BTK				Ph	PH00	8	NSN14TE	TP00DAT-15.P3
Primera	01	02	NS34BTK		▲		Ph/Cry	PH1B	8	NSN14TE	TP00DAT-15.P3
Primera	02	-	NS34BTK		▲		Ph/Cry	PH20	8	NSN14TE	TP00DAT-15.P3
Pulsar	95	96	NS27TK				Ph	PH00	7	NSN11TE	TP00DAT-6.P2
Pulsar	97	98	NS34BTK				Ph	PH00	8	NSN14TE	TP00DAT-15.P3
Pulsar	99	00	MT11BTK	■			Tex/Cry	TC07	7	-	TP00MIT-18.P
Pulsar	01	05	NS34BTK		▲		Ph/Cry	PH1B	8	NSN14TE	TP00DAT-15.P3
Qashqai	06	-	NS34BTK		▲		Ph/Cry	PH20	8	NSN14TE	TP00DAT-15.P3
Quest	04	10	NS34BTK		▲		Ph/Cry	PH20	8	NSN14TE	TP00DAT-15.P3
Rouge (USA)	08	-	NS34BTK		▲		Ph/Cry	PH20	8	NSN14TE	TP00DAT-15.P3
Sentra	00	06	MT11BTK	■			Tex/Cry	TC07	7	-	TP00MIT-18.P
Sentra	07	-	NS34BTK		▲		Ph/Cry	PH20	8	NSN14TE	TP00DAT-15.P3
Serena	96	98	NS27TK				Ph	PH00	7	NSN11TE	TP00DAT-6.P2
Serena	98	-	NS27TK		▲		Ph/Cry	PH1B	7	NSN11TE	TP00DAT-6.P2
Stanza	07	08	NS34BTK		▲		Ph/Cry	PH20	8	NSN14TE	TP00DAT-15.P3
Teana	03	10	NS34JTK		▲		Ph/Cry	PH20	8	TPM383 (Clover)	
Terrano II	95	98	NS27TK				Ph	PH00	7	NSN11TE	TP00DAT-6.P2
Terrano II	99	01	NS27TK		▲		Ph/Cry	PH1B	7	NSN11TE	TP00DAT-6.P2
Terrano II	02	06	NS27TK	■			Tex/Cry	TC07	7	NSN11TE	TP00DAT-6.P2
Tiida	06	12	NS34JTK		▲		Ph/Cry	PH20	8	TPM383 (Clover)	
Tiida	07	-	NS34BTK		▲		Ph/Cry	PH20	8	NSN14TE	TP00DAT-15.P3
Vanette	96	99	NS27TK				Ph	PH00	7	NSN11TE	TP00DAT-6.P2
Vanette	99	-	NS27TK		▲		Ph/Cry	PH1B	7	NSN11TE	TP00DAT-6.P2
X-Terra	00	04	MT11BTK	■			Tex/Cry	TC07	7	-	TP00MIT-18.P
X-Terra	05	08	NS34BTK		▲		Ph/Cry	PH20	8	NSN14TE	TP00DAT-15.P3
X-Trail	98	-	MT11BTK	■			Tex/Cry	TC07	7	-	TP00MIT-18.P
X-Trail	07	13	NS34JTK		▲		Ph/Cry	PH20	8	TPM383 (Clover)	
NISSAN (USA)											
502	03	08	NS34BTK		▲		Ph/Cry	PH20	8	NSN14TE	TP00DAT-15.P3
Altima	00	06	NS34BTK		▲		Ph/Cry	PH20	8	NSN14TE	TP00DAT-15.P3
Frontier	02	-	NS34BTK		▲		Ph/Cry	PH20	8	NSN14TE	TP00DAT-15.P3
Juke	11	-	NS34BTK		▲		Ph/Cry	PH20	8	NSN14TE	TP00DAT-15.P3
Maxima	00	06	NS34BTK		▲		Ph/Cry	PH20	8	NSN14TE	TP00DAT-15.P3
Murano	03	08	NS34BTK		▲		Ph/Cry	PH20	8	NSN14TE	TP00DAT-15.P3
NV Series	12	-	NS34BTK		▲		Ph/Cry	PH20	8	NSN14TE	TP00DAT-15.P3
Pathfinder	99	12	NS34BTK		▲		Ph/Cry	PH20	8	NSN14TE	TP00DAT-15.P3
Quest	04	10	NS34BTK		▲		Ph/Cry	PH20	8	NSN14TE	TP00DAT-15.P3
Quest	07	09	NS34BTK		▲		Ph/Cry	PH20	8	NSN14TE	TP00DAT-15.P3

MODEL	YEAR		KEYLINE REFERENCE	KEYLINE MICRO SERIES			TRANS. TYPE	ID	PAGE	CROSS REFERENCE OF SUBSTITUTE (WHERE AVAILABLE)	
				T	P	M					
NISSAN (USA)											
Sentra	00	12	NS34BTK		▲		Ph/Cry	PH20	8	NSN14TE	TP00DAT-15.P3
Titan	04	-	NS34BTK		▲		Ph/Cry	PH20	8	NSN14TE	TP00DAT-15.P3
Versa	07	-	NS34BTK		▲		Ph/Cry	PH20	8	NSN14TE	TP00DAT-15.P3
Xterra	02	-	NS34BTK		▲		Ph/Cry	PH20	8	NSN14TE	TP00DAT-15.P3
X-Trail (Canada)	05	06	NS34BTK		▲		Ph/Cry	PH20	8	NSN14TE	TP00DAT-15.P3
OPEL (D)											
Agila	04	-	VX5BTK		▲		Ph/Cry	PH20	11	HU100TE	TP00OP-11.P1
Astra / Astra SW	04	-	VX5BTK		▲		Ph/Cry	PH20	11	HU100TE	TP00OP-11.P1
Combo	98	02	RN30TK				Ph	PH00	8	NE73TE	TP00NE-38.P4
Combo	04	-	VX5BTK		▲		Ph/Cry	PH20	11	HU100TE	TP00OP-11.P1
Corsa	04	-	VX5BTK		▲		Ph/Cry	PH20	11	HU100TE	TP00OP-11.P1
Frontera	00	-	HD90TK			●	Meg/Cry	MG10	5	HON58RTE	TP00HOND-21.P
GT Cabriolet	08	-	B106TK		▲		Ph/Cry	PH20	2	-	-
Insignia	08	-	VX5BTK		▲		Ph/Cry	PH20	11	HU100TE	TP00OP-11.P1
Meriva	04	-	VX5BTK		▲		Ph/Cry	PH20	11	HU100TE	TP00OP-11.P1
Movano	98	02	RN30TK				Ph	PH00	8	NE73TE	TP00NE-38.P4
Movano	11	-	PG33TK		▲		Ph/Cry	PH20	8	-	TP00CIT-1.P
Signum	03	-	VX5BTK		▲		Ph/Cry	PH20	11	HU100TE	TP00OP-11.P1
Tigra	04	-	VX5BTK		▲		Ph/Cry	PH20	11	HU100TE	TP00OP-11.P1
Vectra	04	-	VX5BTK		▲		Ph/Cry	PH20	11	HU100TE	TP00OP-11.P1
Vivaro	02	-	RN30TK		▲		Ph/Cry	PH20	8	NE73TE	TP00NE-38.P4
Zafira	06	-	VX5BTK		▲		Ph/Cry	PH20	11	HU100TE	TP00OP-11.P1
PEUGEOT (F)											
106	97	00	RN30TK				Ph	PH00	8	NE73TE	TP00NE-38.P4
106	00	04	RN30TK		▲		Ph/Cry	PH20	8	NE73TE	TP00NE-38.P4
107	05	-	PG33TK	■			Tex/Cry	TCXX	8	-	TP00CIT-1.P
206	01	09	RN30TK		▲		Ph/Cry	PH20	8	NE73TE	TP00NE-38.P4
206 Cabrio	02	-	RN30TK		▲		Ph/Cry	PH20	8	NE73TE	TP00NE-38.P4
206 Plus	08	-	RN30TK		▲		Ph/Cry	PH20	8	NE73TE	TP00NE-38.P4
207	06	-	PG83TK		▲		Ph/Cry	PH20	8	HU83TE	TP00HU-HCA.P
208	12	-	PG83TK		▲		Ph/Cry	PH20	8	HU83TE	TP00HU-HCA.P
306	97	-	RN30TK				Ph	PH00	8	NE73TE	TP00NE-38.P4
307 / 307 S. Wagon	01	09	PG83TK		▲		Ph/Cry	PH20	8	HU83TE	TP00HU-HCA.P
308	07	-	PG83TK		▲		Ph/Cry	PH20	8	HU83TE	TP00HU-HCA.P
407	04	11	PG33TK		▲		Ph/Cry	PH20	8	-	TP00CIT-1.P
407 / 407 S. Wagon	04	-	PG33TK		▲		Ph/Cry	PH20	8	-	TP00CIT-1.P
508	12	-	PG33TK		▲		Ph/Cry	PH20	8	-	TP00CIT-1.P
806	98	-	CN22TK				Ph	PH00	2	SIX9TE	TP00SIX-3.P3
807	02	14	PG83TK		▲		Ph/Cry	PH20	8	HU83TE	TP00HU-HCA.P
1007	05	-	PG33TK		▲		Ph/Cry	PH20	8	-	TP00CIT-1.P
3008	09	-	PG83TK		▲		Ph/Cry	PH20	8	HU83TE	TP00HU-HCA.P
4007	07	-	MT8SBTK		▲		Ph/Cry	PH20	7	MIT11RTE	TP00MIT-8D.P2
5008	09	-	PG83TK		▲		Ph/Cry	PH20	8	HU83TE	TP00HU-HCA.P
Boxer	02	05	FT22TK			●	Meg/Cry	MG10	4	SIP22TE	TP00FI16.P
Expert	97	01	CN22TK				Ph	PH00	2	SIX9TE	TP00SIX-3.P3
Expert	07	-	PG83TK		▲		Ph/Cry	PH20	8	HU83TE	TP00HU-HCA.P
ION	11	-	MT8SBTK		▲		Ph/Cry	PH20	7	MIT11RTE	TP00MIT-8D.P2
Partner	98	00	CN22TK				Ph	PH00	2	SIX9TE	TP00SIX-3.P3
Partner	01	02	CN22TK		▲		Ph/Cry	PH20	2	SIX9TE	TP00SIX-3.P3

MODEL	YEAR	KEYLINE REFERENCE	KEYLINE MICRO SERIES			TRANS. TYPE	ID	PAGE	CROSS REFERENCE OF SUBSTITUTE (WHERE AVAILABLE)	
			T	P	M					
PEUGEOT (F)										
Partner	02	-	PG33TK		▲	Ph/Cry	PH20	8	-	TP00CIT-1.P
Ranch	98	00	CN22TK			Ph	PH00	2	SIX9TE	TP00SIX-3.P3
Ranch	01	02	CN22TK		▲	Ph/Cry	PH20	2	SIX9TE	TP00SIX-3.P3
Ranch	02	07	PG33TK		▲	Ph/Cry	PH20	8	-	TP00CIT-1.P
RCZ	10	-	PG83TK		▲	Ph/Cry	PH20	8	HU83TE	TP00HU-HCA.P
PIAGGIO (I)										
Beverly	02	09	FT1505CTK			Temic	TM10	4	GT15RBTE	FI-13P5
Carnaby	09	-	FT1505CTK			Temic	TM10	4	GT15RBTE	FI-13P5
Fly	09	12	FT1505CTK			Temic	TM10	4	GT15RBTE	FI-13P5
Hexagon	98	03	FT1505CTK			Temic	TM10	4	GT15RBTE	FI-13P5
Liberty	03	-	FT1505CTK			Temic	TM10	4	GT15RBTE	FI-13P5
MP3	06	-	FT22TK			Temic	TM10	4	SIP22TE	TP00FI16.P
Skipper	00	02	FT1505CTK			Temic	TM10	4	GT15RBTE	FI-13P5
Vespa	96	-	FT1505CTK			Temic	TM10	4	GT15RBTE	FI-13P5
X7	07	09	FT1505CTK			Temic	TM10	4	GT15RBTE	FI-13P5
X8	04	06	FT1505CTK			Temic	TM10	4	GT15RBTE	FI-13P5
X8	06	-	FT22TK			Temic	TM10	4	SIP22TE	TP00FI16.P
X9	98	07	FT1505CTK			Temic	TM10	4	GT15RBTE	FI-13P5
Xevo 400	06	-	FT22TK			Temic	TM10	4	SIP22TE	TP00FI16.P
PLYMOUTH (USA)										
Breeze	99	00	Y159TK - Grey	■		Tex/Cry	TCXX	12	CY24TE	TP00CHR-15.P
Neon	00	01	Y159TK - Grey	■		Tex/Cry	TCXX	12	CY24TE	TP00CHR-15.P
PONTIAC (USA)										
G5	07	09	B106TK		▲	Ph/Cry	PH20	2	-	-
G5 Pursuit (Canada)	05	10	B106TK		▲	Ph/Cry	PH20	2	-	-
G5 Pursuit (Canada)	05	-	B106TK		▲	Ph/Cry	PH20	2	-	-
G6	04	10	B106TK		▲	Ph/Cry	PH20	2	-	-
G8	08	-	B106TK		▲	Ph/Cry	PH20	2	-	-
Solstice	06	09	B106TK		▲	Ph/Cry	PH20	2	-	-
Torrent	06	09	B106TK		▲	Ph/Cry	PH20	2	-	-
Vibe	09	10	TR47TK	■		Tex/Cry	TCXX	10	TOY43TE	TP00TOYO-15.P
PORSCHE (D)										
911	98	99	V66TK		●	Meg	MG00	11	HU66TE	TP00HU-HAA.P
911	00	-	V66TK		●	Meg/Cry	MG10	11	HU66TE	TP00HU-HAA.P
Boxster	96	98	V66TK		●	Meg	MG00	11	HU66TE	TP00HU-HAA.P
Boxster	99	-	V66TK		●	Meg/Cry	MG10	11	HU66TE	TP00HU-HAA.P
Cayenne	04	09	V66TK		●	Meg/Cry	MG10	11	HU66TE	TP00HU-HAA.P
Cayman	06	12	V66TK		●	Meg/Cry	MG10	11	HU66TE	TP00HU-HAA.P
PROTON (MAL)										
Inspira	10	-	MT8SBTK		●	Meg/Cry	MG10	7	MIT11RTE	TP00MIT-8D.P2
Jumbuck	02	10	MT8SBTK		●	Meg/Cry	MG10	7	MIT11RTE	TP00MIT-8D.P2
Saga BLM	08	10	MT8SBTK		●	Meg/Cry	MG10	7	MIT11RTE	TP00MIT-8D.P2
RAM (USA)										
3500 CC	10	10	Y159TK - Tan		▲	Ph/Cry	PH20	12	CY24TE	TP00CHR-15.P
4500 CC	10	10	Y159TK - Tan		▲	Ph/Cry	PH20	12	CY24TE	TP00CHR-15.P
5500 CC	10	10	Y159TK - Tan		▲	Ph/Cry	PH20	12	CY24TE	TP00CHR-15.P
Dakota	10	11	Y159TK - Tan		▲	Ph/Cry	PH20	12	CY24TE	TP00CHR-15.P
RENAULT (F)										
Avantime	01	03	RN30TK	■		Tex/Cry	TC04	8	NE73TE	TP00NE-38.P4

MODEL	YEAR		KEYLINE REFERENCE	KEYLINE MICRO SERIES			TRANS. TYPE	ID	PAGE	CROSS REFERENCE OF SUBSTITUTE (WHERE AVAILABLE)	
				T	P	M					
RENAULT (F)											
Clio	95	01	VE20TK				Ph	PH00	11	VAC102TE	TP00VA-34.P4
Clio	95	01	RN30TK				Ph	PH00	8	NE73TE	TP00NE-38.P4
Clio	01	05	RN30TK	▲			Ph/Cry	PH20	8	NE73TE	TP00NE-38.P4
Clio	06	11	PG33TK	▲			Ph/Cry	PH20	8	-	TP00CIT-1.P
Clio	12	-	PG33TK	▲			Ph/Cry	PH20	8	-	TP00CIT-1.P
Espace	95	-	RN30TK				Ph	PH00	8	NE73TE	TP00NE-38.P4
Kangoo	98	01	VE20TK				Ph	PH00	11	VAC102TE	TP00VA-34.P4
Kangoo	09	-	PG33TK	▲			Ph/Cry	PH20	8	-	TP00CIT-1.P
Kangoo Express	10	-	PG33TK	▲			Ph/Cry	PH20	8	-	TP00CIT-1.P
Laguna	96	01	RN30TK				Ph	PH00	8	NE73TE	TP00NE-38.P4
Laguna	96	01	VE20TK				Ph	PH00	11	VAC102TE	TP00VA-34.P4
Master	99	01	RN30TK				Ph	PH00	8	NE73TE	TP00NE-38.P4
Master	11	-	PG33TK	▲			Ph/Cry	PH20	8	-	TP00CIT-1.P
Mégane	96	98	RN30TK				Ph	PH00	8	NE73TE	TP00NE-38.P4
Mégane	98	03	RN30TK	■			Tex/Cry	TC04	8	NE73TE	TP00NE-38.P4
Modus	04	08	PG33TK	▲			Ph/Cry	PH20	8	-	TP00CIT-1.P
New Clio	06	-	PG33TK	▲			Ph/Cry	PH20	8	-	TP00CIT-1.P
Safrane	95	-	RN30TK				Ph	PH00	8	NE73TE	TP00NE-38.P4
Safrane	95	-	VE20TK				Ph	PH00	11	VAC102TE	TP00VA-34.P4
Scénic	96	98	RN30TK				Ph	PH00	8	NE73TE	TP00NE-38.P4
Scénic	98	00	RN30TK	■			Tex/Cry	TC04	8	NE73TE	TP00NE-38.P4
Trafic	02	-	RN30TK		▲		Ph/Cry	PH20	8	NE73TE	TP00NE-38.P4
Twingo	95	01	VE20TK				Ph	PH00	11	VAC102TE	TP00VA-34.P4
Twingo	07	11	PG33TK	▲			Ph/Cry	PH20	8	-	TP00CIT-1.P
Twingo	12	-	PG33TK	▲			Ph/Cry	PH20	8	-	TP00CIT-1.P
SATURN (USA)											
Astra	08	09	B106TK		▲		Ph/Cry	PH20	2	-	-
Aura	07	09	B106TK		▲		Ph/Cry	PH20	2	-	-
Outlook	07	09	B106TK		▲		Ph/Cry	PH20	2	-	-
Sky	07	10	B106TK		▲		Ph/Cry	PH20	2	-	-
SCION (USA)											
iQ (CDN)	12	13	TR47TK	■			Tex/Cry	TP80	10	TOY43TE	TP00TOYO-15.P
TC	05	10	TR47TK	■			Tex/Cry	TCXX	10	TOY43TE	TP00TOYO-15.P
TC	11	15	TR47TK	■			Tex/Cry	TP80	10	TOY43TE	TP00TOYO-15.P
XA	04	07	TR47TK	■			Tex/Cry	TCXX	10	TOY43TE	TP00TOYO-15.P
XB	04	08	TR47TK	■			Tex/Cry	TCXX	10	TOY43TE	TP00TOYO-15.P
XB (CDN)	11	12	TR47TK	■			Tex/Cry	TP80	10	TOY43TE	TP00TOYO-15.P
XD	08	-	TR47TK	■			Tex/Cry	TCXX	10	TOY43TE	TP00TOYO-15.P
XD (CDN)	11	12	TR47TK	■			Tex/Cry	TP80	10	TOY43TE	TP00TOYO-15.P
SEAT (E)											
Alhambra	96	98	V66TK				Ph	PH00	11	HU66TE	TP00HU-HAA.P
Alhambra	02	08	V66TK			●	Meg/Cry	MG10	11	HU66TE	TP00HU-HAA.P
Altea	04	-	V66TK			●	Meg/Cry	MG10	11	HU66TE	TP00HU-HAA.P
Altea Freetrack	07	-	V66TK			●	Meg/Cry	MG10	11	HU66TE	TP00HU-HAA.P
Altea XL	06	-	V66TK			●	Meg/Cry	MG10	11	HU66TE	TP00HU-HAA.P
Arosa	97	99	V66TK				Ph	PH00	11	HU66TE	TP00HU-HAA.P
Cordoba	01	-	V66TK			●	Meg/Cry	MG10	11	HU66TE	TP00HU-HAA.P
Exeo	08	-	V66TK			●	Meg/Cry	MG10	11	HU66TE	TP00HU-HAA.P
Freetrack	08	15	V66TK			●	Meg/Cry	MG10	11	HU66TE	TP00HU-HAA.P

MODEL	YEAR	KEYLINE REFERENCE	KEYLINE MICRO SERIES			TRANS. TYPE	ID	PAGE	CROSS REFERENCE OF SUBSTITUTE (WHERE AVAILABLE)	
			T	P	M					
SEAT (E)										
Ibiza	00	-	V66TK			● Meg/Cry	MG10	11	HU66TE	TP00HU-HAA.P
Leon	99	-	V66TK			● Meg/Cry	MG10	11	HU66TE	TP00HU-HAA.P
Mii	12	-	V66TK			● Meg/Cry	MG10	11	HU66TE	TP00HU-HAA.P
Toledo	99	04	V66TK			● Meg	MG00	11	HU66TE	TP00HU-HAA.P
Toledo	05	-	V66TK			● Meg/Cry	MG10	11	HU66TE	TP00HU-HAA.P
ŠKODA (CZ)										
Citigo	12	-	V66TK			● Meg/Cry	MG10	11	HU66TE	TP00HU-HAA.P
Fabia	00	04	V66TK			● Meg/Cry	MG10	11	HU66TE	TP00HU-HAA.P
Fabia	05	10	V66TK			● Meg/Cry	MG10	11	HU66TE	TP00HU-HAA.P
Fabia	11	-	V66TK			● Meg/Cry	MG10	11	HU66TE	TP00HU-HAA.P
Felicia	99	-	V66TK			● Meg/Cry	MG10	11	HU66TE	TP00HU-HAA.P
Laura	07	12	V66TK			● Meg/Cry	MG10	11	HU66TE	TP00HU-HAA.P
Octavia	01	-	V66TK			● Meg/Cry	MG10	11	HU66TE	TP00HU-HAA.P
Praktik	07	15	V66TK			● Meg/Cry	MG10	11	HU66TE	TP00HU-HAA.P
Roomster	06	-	V66TK			● Meg/Cry	MG10	11	HU66TE	TP00HU-HAA.P
Roomster Scout	07	-	V66TK			● Meg/Cry	MG10	11	HU66TE	TP00HU-HAA.P
Superb	02	-	V66TK			● Meg/Cry	MG10	11	HU66TE	TP00HU-HAA.P
Yeti	09	-	V66TK			● Meg/Cry	MG10	11	HU66TE	TP00HU-HAA.P
SMART (D)										
Forfour	04	06	MT15TK		▲	Ph/Cry	PH20	7	HU56RTE	-
ForTwo	08	-	PG33TK		▲	Ph/Cry	PH20	8	-	TP00CIT-1.P
SSANGYONG (ROK)										
Actyon	07	-	SY3STK	■		Tex/Cry	TCXX	10	TOY43TE	TP00TOYO-15.P
Actyon	08	12	SY3STK			● Meg/Cry	MG10	10	TOY43TE	TP00TOYO-15.P
Kyron	05	-	SY3STK	■		Tex/Cry	TCXX	10	TOY43TE	TP00TOYO-15.P
Rexton	08	12	SY3STK			● Meg/Cry	MG10	10	SSY3TE	SSA-1P1
STERLING (USA)										
Bullet	08	09	Y159TK - Tan		▲	Ph/Cry	PH20	12	CY24TE	TP00CHR-15.P
SUBARU (J)										
B9 Tribeca	05	07	SUB2TK	■		Tex/Cry	TC07	9	NSN14TE	TP00DAT-15.P2
B9 Tribeca	07	-	SUB1TK	■		Tex/Cry	TCXX	9	DAT17TE	TP00SUB-2P
Baja	05	07	SUB2TK	■		Tex/Cry	TCXX	9	NSN14TE	TP00DAT-15.P2
Forester	98	03	MT11BTK	■		Tex/Cry	TC07	7	-	TP00MIT-18.P
Forester	04	07	SUB2TK	■		Tex/Cry	TCXX	9	NSN14TE	TP00DAT-15.P2
Forester	11	-	SUB1TK	■		Tex/Cry	TPXX	9	DAT17TE	TP00SUB-2P
Forester (Aus)	98	04	SUB2TK	■		Tex/Cry	TCXX	9	NSN14TE	TP00DAT-15.P2
Impreza	96	00	NS27TK			Ph	PH00	7	NSN11TE	TP00DAT-6.P2
Impreza	98	03	MT11BTK	■		Tex/Cry	TC07	7	-	TP00MIT-18.P
Impreza	04	07	SUB2TK	■		Tex/Cry	TP02	9	NSN14TE	TP00DAT-15.P2
Impreza	08	-	SUB1TK	■		Tex/Cry	TPXX	9	DAT17TE	TP00SUB-2P
Impreza (Aus)	98	04	SUB2TK	■		Tex/Cry	TCXX	9	NSN14TE	TP00DAT-15.P2
Justy	96	03	SU15TK	■		Tex/Cry	TCXX	8	SZ12TE	TP00SUZU-10P
Legacy	96	98	NS27TK			Ph	PH00	7	NSN11TE	TP00DAT-6.P2
Legacy	98	04	SUB2TK	■		Tex/Cry	TC07	9	NSN14TE	TP00DAT-15.P2
Legacy (EU)	04	-	SUB1TK	■		Tex/Cry	TPXX	9	DAT17TE	TP00SUB-2P
Legacy (USA)	05	-	SUB2TK	■		Tex/Cry	TC07	9	NSN14TE	TP00DAT-15.P2
Liberty (Aus)	98	03	SUB2TK	■		Tex/Cry	TCXX	9	NSN14TE	TP00DAT-15.P2
Outback	96	98	NS27TK			Ph	PH00	7	NSN11TE	TP00DAT-6.P2
Outback	98	04	MT11BTK	■		Tex/Cry	TC07	7	-	TP00MIT-18.P

MODEL	YEAR		KEYLINE REFERENCE	KEYLINE MICRO SERIES			TRANS. TYPE	ID	PAGE	CROSS REFERENCE OF SUBSTITUTE (WHERE AVAILABLE)	
				T	P	M					
SUBARU (J)											
Outback (Aus)	98	03	SUB2TK	■			Tex/Cry	TCXX	9	NSN14TE	TP00DAT-15.P2
Outback (EU)	04	-	SUB1TK	■			Tex/Cry	TC07	9	DAT17TE	TP00SUB-2P
Outback (USA)	05	-	SUB2TK	■			Tex/Cry	TC07	9	NSN14TE	TP00DAT-15.P2
Trezia	11	14	TR47TK	■			Tex/Cry	TP80	10	TOY43TE	TP00TOYO-15.P
WRX	00	-	SUB2TK	■			Tex/Cry	TC07	9	NSN14TE	TP00DAT-15.P2
SUZUKI (J)											
Alto	96	02	SU17TK	■			Tex	TX00	9	SZ11RTE	TP00SUZU-8.P1
Alto	96	02	SU17TK	■			Tex/Cry	TCXX	9	SZ11RTE	TP00SUZU-8.P1
Alto	96	02	SU15TK	■			Tex/Cry	TCXX	8	SZ12TE	TP00SUZU-10P
Alto	00	08	SU17STK	■			Tex/Cry	TCXX	9	SZ11TE	TP00SUZU-8IP1
Alto	02	07	SU17TK	■			Tex/Cry	TC02	9	SZ11RTE	TP00SUZU-8.P1
Alto	08	13	SU19JTK		▲		Ph/Cry	PH20	9	TPM407 (Clover)	
Alto	09	-	SU19TK		▲		Ph/Cry	PH20	9	HU133RTE	TP00SUZU-14.P2
Baleno	97	01	SU17TK	■			Tex	TX00	9	SZ11RTE	TP00SUZU-8.P1
Baleno	97	01	SU15TK	■			Tex	TX00	8	SZ12TE	TP00SUZU-10P
Cervo	06	09	SU19JTK		▲		Ph/Cry	PH20	9	TPM407 (Clover)	
Equator	09	-	NS34BTK		▲		Ph/Cry	PH20	8	NSN14TE	TP00DAT-15.P3
Escudo	96	02	SU15TK	■			Tex	TX00	8	SZ12TE	TP00SUZU-10P
Escudo (J)	96	02	SU17TK	■			Tex/Cry	TCXX	9	SZ11RTE	TP00SUZU-8.P1
Escudo	05	15	SU19JTK		▲		Ph/Cry	PH20	9	TPM407 (Clover)	
Grand Vitara	96	02	SU17TK	■			Tex/Cry	TCXX	9	SZ11RTE	TP00SUZU-8.P1
Grand Vitara	02	-	SU19TK		▲		Ph/Cry	PH20	9	HU133RTE	TP00SUZU-14.P2
Ignis	00	-	SU17TK	■			Tex/Cry	TC02	9	SZ11RTE	TP00SUZU-8.P1
Jimny	99	02	SU17TK	■			Tex	TX00	9	SZ11RTE	TP00SUZU-8.P1
Jimny	02	-	SU17TK	■			Tex/Cry	TC02	9	SZ11RTE	TP00SUZU-8.P1
Landy	07	10	SU19JTK		▲		Ph/Cry	PH20	9	TPM407 (Clover)	
MR Wagon	06	11	SU19JTK		▲		Ph/Cry	PH20	9	TPM407 (Clover)	
Splash	08	14	SU19JTK		▲		Ph/Cry	PH20	9	TPM407 (Clover)	
Splash	08	-	SU19TK		▲		Ph/Cry	PH20	9	HU133RTE	TP00SUZU-14.P2
Swift	95	04	SU15TK	■			Tex	TX00	8	SZ12TE	TP00SUZU-10P
Swift	95	04	SU17TK	■			Tex	TX00	9	SZ11RTE	TP00SUZU-8.P1
Swift	95	04	SU17TK	■			Tex/Cry	TCXX	9	SZ11RTE	TP00SUZU-8.P1
Swift	05	13	SU19JTK		▲		Ph/Cry	PH20	9	TPM407 (Clover)	
Swift	05	-	SU19TK		▲		Ph/Cry	PH20	9	HU133RTE	TP00SUZU-14.P2
SX4	06	09	SU19JTK		▲		Ph/Cry	PH20	9	TPM407 (Clover)	
SX4	06	-	SU19TK		▲		Ph/Cry	PH20	9	HU133RTE	TP00SUZU-14.P2
Vitara	95	01	SU17TK	■			Tex	TX00	9	SZ11RTE	TP00SUZU-8.P1
Vitara	95	01	SU15TK	■			Tex	TX00	8	SZ12TE	TP00SUZU-10P
Vitara	96	01	SU17TK	■			Tex/Cry	TCXX	9	SZ11RTE	TP00SUZU-8.P1
Wagon R	98	01	SU17TK	■			Tex	TX00	9	SZ11RTE	TP00SUZU-8.P1
Wagon R	04	12	SU19JTK		▲		Ph/Cry	PH20	9	TPM407 (Clover)	
SUZUKI (USA)											
XL7	07	-	B106TK		▲		Ph/Cry	PH20	2	-	-
TOYOTA (J)											
4 Runner	95	02	TR47TK	■			Tex	TX00	10	TOY43TE	TP00TOYO-15.P
4 Runner	03	-	TR47TK	■			Tex/Cry	TCXX	10	TOY43TE	TP00TOYO-15.P
Alphard	05	-	TR47TK	■			Tex/Cry	TCXX	10	TOY43TE	TP00TOYO-15.P
Aurion (Aus)	06	-	TR47TK	■			Tex/Cry	TCXX	10	TOY43TE	TP00TOYO-15.P
Aurion (Aus)	11	16	TR47TK	■			Tex/Cry	TP80	10	TOY43TE	TP00TOYO-15.P

MODEL	YEAR	KEYLINE REFERENCE	KEYLINE MICRO SERIES			TRANS. TYPE	ID	PAGE	CROSS REFERENCE OF SUBSTITUTE (WHERE AVAILABLE)	
			T	P	M					
TOYOTA (J)										
Auris	06	-	TR47TK	■		Tex/Cry	TCXX	10	TOY43TE	TP00TOYO-15.P
Auris	09	12	TR47TK	■		Tex/Cry	TP80	10	TOY43TE	TP00TOYO-15.P
Auris (EU)	09	12	TR56TK	■		Tex/Cry	TP80	11	TOY47TE	TP00TOYO-19.P
Avensis	98	00	TR56TK	■		Tex	TX00	11	TOY47TE	TP00TOYO-19.P
Avensis	10	15	TR56TK	■		Tex/Cry	TP80	11	TOY47TE	TP00TOYO-19.P
Avensis Verso	01	03	TR47TK	■		Tex	TX00	10	TOY43TE	TP00TOYO-15.P
Camry	95	03	TR47TK	■		Tex	TX00	10	TOY43TE	TP00TOYO-15.P
Camry	96	05	TR47TK	■		Tex/Cry	TCXX	10	TOY43TE	TP00TOYO-15.P
Camry	11	15	TR47TK	■		Tex/Cry	TP80	10	TOY43TE	TP00TOYO-15.P
Carina	96	00	TR56TK	■		Tex	TX00	11	TOY47TE	TP00TOYO-19.P
Carina	96	00	TR47TK			Ph	PH00	10	TOY43TE	TP00TOYO-15.P
Celica	96	00	TR47TK			Ph	PH00	10	TOY43TE	TP00TOYO-15.P
Celica	00	05	TR47TK	■		Tex	TX00	10	TOY43TE	TP00TOYO-15.P
Celsior	98	00	TR49TK	■		Tex	TX00	10	TOY40BTE	-
Celsior	98	04	TR51TK	■		Tex	TX00	11	TOY40BTE	TP00TOYO-18.P
Celsior	00	04	TR51TK	■		Tex/Cry	TCXX	11	TOY40BTE	TP00TOYO-18.P
Century	98	-	TR47TK	■		Tex	TX00	10	TOY43TE	TP00TOYO-15.P
Colorada	97	-	TR47TK	■		Tex	TX00	10	TOY43TE	TP00TOYO-15.P
Corolla	96	99	TR47TK	■		Tex	TX00	10	TOY43TE	TP00TOYO-15.P
Corolla	96	04	TR47TK	■		Tex	TX00	10	TOY43TE	TP00TOYO-15.P
Corolla	05	-	TR47TK	■		Tex/Cry	TCXX	10	TOY43TE	TP00TOYO-15.P
Corolla	09	13	TR47TK	■		Tex/Cry	TP80	10	TOY43TE	TP00TOYO-15.P
Echo	99	05	TR41TK	■		Tex	TX00	10	TOY41RATE	TP00TOYO-20D.P
Echo Verso	02	05	TR47TK	■		Tex/Cry	TCXX	10	TOY43TE	TP00TOYO-15.P
FJ Cruiser	07	-	TR47TK	■		Tex/Cry	TCXX	10	TOY43TE	TP00TOYO-15.P
FJ Cruiser	11	15	TR47TK	■		Tex/Cry	TP80	10	TOY43TE	TP00TOYO-15.P
Fortuner	07	-	TR47TK	■		Tex/Cry	TCXX	10	TOY43TE	TP00TOYO-15.P
Fortuner	09	15	TR47TK	■		Tex/Cry	TP80	10	TOY43TE	TP00TOYO-15.P
Gaia	99	04	TR47TK	■		Tex	TX00	10	TOY43TE	TP00TOYO-15.P
Hiace	97	06	TR47TK	■		Tex	TX00	10	TOY43TE	TP00TOYO-15.P
Hiace	07	-	TR47TK	■		Tex/Cry	TCXX	10	TOY43TE	TP00TOYO-15.P
Hiace	10	14	TR47TK	■		Tex/Cry	TP80	10	TOY43TE	TP00TOYO-15.P
Hilux	99	04	TR47TK	■		Tex/Cry	TCXX	10	TOY43TE	TP00TOYO-15.P
Hilux	05	10	TR47TK	■		Tex/Cry	TCXX	10	TOY43TE	TP00TOYO-15.P
Hilux	09	15	TR47TK	■		Tex/Cry	TP80	10	TOY43TE	TP00TOYO-15.P
Innova	09	15	TR47TK	■		Tex/Cry	TP80	10	TOY43TE	TP00TOYO-15.P
Innova Kijang	05	-	TR47TK	■		Tex/Cry	TCXX	10	TOY43TE	TP00TOYO-15.P
iQ	08	-	TR47TK	■		Tex/Cry	TCXX	10	TOY43TE	TP00TOYO-15.P
Land Cruiser	95	03	TR49TK	■		Tex	TX00	10	TOY40BTE	-
Land Cruiser	95	03	TR47TK	■		Tex	TX00	10	TOY43TE	TP00TOYO-15.P
Land Cruiser	95	03	TR51TK	■		Tex	TX00	11	TOY40BTE	TP00TOYO-18.P
Land Cruiser	98	02	TR47TK	■		Tex	TX00	10	TOY43TE	TP00TOYO-15.P
Land Cruiser	03	-	TR47TK	■		Tex/Cry	TCXX	10	TOY43TE	TP00TOYO-15.P
Land Cruiser (EUR)	03	-	TR47TK	■		Tex/Cry	TCXX	10	TOY43TE	TP00TOYO-15.P
Land Cruiser 100	98	02	TR47TK	■		Tex	TX00	10	TOY43TE	TP00TOYO-15.P
Land Cruiser 100	03	08	TR47TK	■		Tex/Cry	TCXX	10	TOY43TE	TP00TOYO-15.P
Land Cruiser 120	02	-	TR47TK	■		Tex/Cry	TCXX	10	TOY43TE	TP00TOYO-15.P
Land Cruiser 200	11	15	TR47TK	■		Tex/Cry	TP80	10	TOY43TE	TP00TOYO-15.P
Land Cruiser 90	96	02	TR47TK	■		Tex	TX00	10	TOY43TE	TP00TOYO-15.P

MODEL	YEAR	KEYLINE REFERENCE	KEYLINE MICRO SERIES			TRANS. TYPE	ID	PAGE	CROSS REFERENCE OF SUBSTITUTE (WHERE AVAILABLE)	
			T	P	M					
TOYOTA (J)										
Land Cruiser Prado	02	-	TR47TK	■		Tex/Cry	TCXX	10	TOY43TE	TP00TOYO-15.P
Land Cruiser Prado	09	10	TR47TK	■		Tex/Cry	TP80	10	TOY43TE	TP00TOYO-15.P
Matrix	05	-	TR47TK	■		Tex/Cry	TCXX	10	TOY43TE	TP00TOYO-15.P
MR 2	97	07	TR41TK	■		Tex	TX00	10	TOY41RATE	TP00TOYO-20D.P
Picnic	96	03	TR47TK	■		Tex	TX00	10	TOY43TE	TP00TOYO-15.P
Picnic	03	08	TR47TK	■		Tex/Cry	TCXX	10	TOY43TE	TP00TOYO-15.P
Prado	96	-	TR47TK	■		Tex	TX00	10	TOY43TE	TP00TOYO-15.P
Previa	00	08	TR47TK	■		Tex/Cry	TCXX	10	TOY43TE	TP00TOYO-15.P
Prius	00	03	TR47TK	■		Tex	TX00	10	TOY43TE	TP00TOYO-15.P
Progress	98	-	TR48TK	■		Tex	TX00	10	TOY48BTE	TP00TOYO-36.P
Rav 4	96	04	TR47TK	■		Tex	TX00	10	TOY43TE	TP00TOYO-15.P
Rav 4	05	-	TR47TK	■		Tex/Cry	TCXX	10	TOY43TE	TP00TOYO-15.P
Rav 4	10	12	TR47TK	■		Tex/Cry	TP80	10	TOY43TE	TP00TOYO-15.P
Reiz	05	-	TR47TK	■		Tex/Cry	TCXX	10	TOY43TE	TP00TOYO-15.P
Sequoia	01	03	TR47TK	■		Tex	TX00	10	TOY43TE	TP00TOYO-15.P
Sequoia	03	-	TR47TK	■		Tex/Cry	TCXX	10	TOY43TE	TP00TOYO-15.P
Sienna	99	03	TR47TK	■		Tex	TX00	10	TOY43TE	TP00TOYO-15.P
Sienna	04	-	TR47TK	■		Tex/Cry	TCXX	10	TOY43TE	TP00TOYO-15.P
Solara	99	03	TR47TK	■		Tex	TX00	10	TOY43TE	TP00TOYO-15.P
Solara	04	-	TR47TK	■		Tex/Cry	TCXX	10	TOY43TE	TP00TOYO-15.P
Starlet	97	99	TR41TK			Ph	PH00	10	TOY41RATE	TP00TOYO-20D.P
T.U.V.	03	-	TR47TK	■		Tex/Cry	TCXX	10	TOY43TE	TP00TOYO-15.P
Tacoma	04	-	TR47TK	■		Tex/Cry	TCXX	10	TOY43TE	TP00TOYO-15.P
Verso	09	15	TR47TK	■		Tex/Cry	TP80	10	TOY43TE	TP00TOYO-15.P
Verso-S	11	14	TR47TK	■		Tex/Cry	TP80	10	TOY43TE	TP00TOYO-15.P
Vios	07	-	TR47TK	■		Tex/Cry	TCXX	10	TOY43TE	TP00TOYO-15.P
Wish	04	-	TR47TK	■		Tex/Cry	TCXX	10	TOY43TE	TP00TOYO-15.P
Yaris	99	01	TR41TK	■		Tex	TX00	10	TOY41RATE	TP00TOYO-20D.P
Yaris	01	05	TR56TK	■		Tex	TX00	11	TOY47TE	TP00TOYO-19.P
Yaris	11	14	TR47TK	■		Tex/Cry	TP80	10	TOY43TE	TP00TOYO-15.P
Yaris	11	14	TR56TK	■		Tex/Cry	TP80	11	TOY47TE	TP00TOYO-19.P
TOYOTA (USA)										
4Runner	99	02	TR47TK	■		Tex	TX00	10	TOY43TE	TP00TOYO-15.P
4Runner	03	10	TR47TK	■		Tex/Cry	TCXX	10	TOY43TE	TP00TOYO-15.P
4Runner	11	16	TR47TK	■		Tex/Cry	TP80	10	TOY43TE	TP00TOYO-15.P
Avalon	98	04	TR47TK	■		Tex	TX00	10	TOY43TE	TP00TOYO-15.P
Avalon	05	-	TR47TK	■		Tex/Cry	TCXX	10	TOY43TE	TP00TOYO-15.P
Avalon	12	12	TR47TK	■		Tex/Cry	TP80	10	TOY43TE	TP00TOYO-15.P
Avanza	04	-	TR47TK	■		Tex/Cry	TCXX	10	TOY43TE	TP00TOYO-15.P
Camry	12	14	TR47TK	■		Tex/Cry	TP80	10	TOY43TE	TP00TOYO-15.P
Corolla	05	10	TR47TK	■		Tex/Cry	TCXX	10	TOY43TE	TP00TOYO-15.P
Corolla	10	14	TR47TK	■		Tex/Cry	TP80	10	TOY43TE	TP00TOYO-15.P
FJ Cruiser	07	10	TR47TK	■		Tex/Cry	TCXX	10	TOY43TE	TP00TOYO-15.P
FJ Cruiser	11	15	TR47TK	■		Tex/Cry	TP80	10	TOY43TE	TP00TOYO-15.P
Hiace	07	-	TR47TK	■		Tex/Cry	TCXX	10	TOY43TE	TP00TOYO-15.P
Highlander	01	03	TR47TK	■		Tex	TX00	10	TOY43TE	TP00TOYO-15.P
Highlander	03	-	TR47TK	■		Tex/Cry	TCXX	10	TOY43TE	TP00TOYO-15.P
Highlander	11	13	TR47TK	■		Tex/Cry	TP80	10	TOY43TE	TP00TOYO-15.P
Matrix	11	14	TR47TK	■		Tex/Cry	TP80	10	TOY43TE	TP00TOYO-15.P

MODEL	YEAR		KEYLINE REFERENCE	KEYLINE MICRO SERIES			TRANS. TYPE	ID	PAGE	CROSS REFERENCE OF SUBSTITUTE (WHERE AVAILABLE)	
				T	P	M					
TOYOTA (USA)											
Prius C	12	14	TR47TK	■			Tex/Cry	TP80	10	TOY43TE	TP00TOYO-15.P
Rav 4	11	12	TR47TK	■			Tex/Cry	TP80	10	TOY43TE	TP00TOYO-15.P
Sequoia	01	-	TR47TK	■			Tex/Cry	TCXX	10	TOY43TE	TP00TOYO-15.P
Sequoia	11	14	TR47TK	■			Tex/Cry	TP80	10	TOY43TE	TP00TOYO-15.P
Sienna	99	-	TR47TK	■			Tex/Cry	TCXX	10	TOY43TE	TP00TOYO-15.P
Sienna	11	14	TR47TK	■			Tex/Cry	TP80	10	TOY43TE	TP00TOYO-15.P
Solara	02	-	TR47TK	■			Tex/Cry	TCXX	10	TOY43TE	TP00TOYO-15.P
Tacoma	05	-	TR47TK	■			Tex/Cry	TCXX	10	TOY43TE	TP00TOYO-15.P
Tacoma	11	15	TR47TK	■			Tex/Cry	TP80	10	TOY43TE	TP00TOYO-15.P
Tundra	05	-	TR47TK	■			Tex/Cry	TCXX	10	TOY43TE	TP00TOYO-15.P
Tundra	11	-	TR47TK	■			Tex/Cry	TP80	10	TOY43TE	TP00TOYO-15.P
Venza	10	14	TR47TK	■			Tex/Cry	TP80	10	TOY43TE	TP00TOYO-15.P
Yaris	07	-	TR47TK	■			Tex/Cry	TCXX	10	TOY43TE	TP00TOYO-15.P
Yaris	12	14	TR47TK	■			Tex/Cry	TP80	10	TOY43TE	TP00TOYO-15.P
TOYOTA JAPAN											
bB	00	05	TR47TK	■			Tex/Cry	TCXX	10	TOY43TE	TP00TOYO-15.P
Caldina	02	04	TR47TK	■			Tex/Cry	TCXX	10	TOY43TE	TP00TOYO-15.P
Corolla Fielder	04	-	TR47TK	■			Tex/Cry	TCXX	10	TOY43TE	TP00TOYO-15.P
Corolla Runix	04	-	TR47TK	■			Tex/Cry	TCXX	10	TOY43TE	TP00TOYO-15.P
Corolla Spacio	03	-	TR47TK	■			Tex/Cry	TCXX	10	TOY43TE	TP00TOYO-15.P
Dyna	08	-	TR47TK	■			Tex/Cry	TCXX	10	TOY43TE	TP00TOYO-15.P
Estima	01	03	TR47TK				Ph	PH00	10	TOY43TE	TP00TOYO-15.P
Estima	03	-	TR47TK	■			Tex/Cry	TCXX	10	TOY43TE	TP00TOYO-15.P
Fun Cargo	03	05	TR47TK	■			Tex/Cry	TCXX	10	TOY43TE	TP00TOYO-15.P
Hiace	95	-	TR47TK	■			Tex/Cry	TCXX	10	TOY43TE	TP00TOYO-15.P
Hilux	99	04	TR47TK	■			Tex	TX00	10	TOY43TE	TP00TOYO-15.P
Hilux	05	-	TR47TK	■			Tex/Cry	TCXX	10	TOY43TE	TP00TOYO-15.P
Ipsum	96	-	TR47TK	■			Tex/Cry	TCXX	10	TOY43TE	TP00TOYO-15.P
Isis	03	-	TR47TK	■			Tex/Cry	TCXX	10	TOY43TE	TP00TOYO-15.P
Ist	03	-	TR47TK	■			Tex/Cry	TCXX	10	TOY43TE	TP00TOYO-15.P
Kluger	01	-	TR47TK	■			Tex/Cry	TCXX	10	TOY43TE	TP00TOYO-15.P
Land Cruiser Prado	00	02	TR47TK	■			Tex	TX00	10	TOY43TE	TP00TOYO-15.P
Land Cruiser Prado	02	-	TR47TK	■			Tex/Cry	TCXX	10	TOY43TE	TP00TOYO-15.P
Mark 2	00	06	TR47TK	■			Tex/Cry	TCXX	10	TOY43TE	TP00TOYO-15.P
Mark X	04	-	TR47TK	■			Tex/Cry	TCXX	10	TOY43TE	TP00TOYO-15.P
Noah	04	-	TR47TK	■			Tex/Cry	TCXX	10	TOY43TE	TP00TOYO-15.P
Open Deck	00	05	TR47TK	■			Tex/Cry	TCXX	10	TOY43TE	TP00TOYO-15.P
Platz	03	05	TR47TK	■			Tex/Cry	TCXX	10	TOY43TE	TP00TOYO-15.P
Pronard	00	02	TR47TK	■			Tex	TX00	10	TOY43TE	TP00TOYO-15.P
Raum	03	-	TR47TK	■			Tex/Cry	TCXX	10	TOY43TE	TP00TOYO-15.P
Rav 4	03	-	TR47TK	■			Tex/Cry	TCXX	10	TOY43TE	TP00TOYO-15.P
Regiusace	07	-	TR47TK	■			Tex/Cry	TCXX	10	TOY43TE	TP00TOYO-15.P
Sienta	03	-	TR47TK	■			Tex/Cry	TCXX	10	TOY43TE	TP00TOYO-15.P
Some models	96	-	TR51TK	■			Tex/Cry	TCXX	11	TOY40BTE	TP00TOYO-18.P
Toyoace	08	-	TR47TK	■			Tex/Cry	TCXX	10	TOY43TE	TP00TOYO-15.P
Vanguard	05	-	TR47TK	■			Tex/Cry	TCXX	10	TOY43TE	TP00TOYO-15.P
Verossa	01	04	TR47TK	■			Tex	TX00	10	TOY43TE	TP00TOYO-15.P
Vitz	03	-	TR47TK	■			Tex/Cry	TCXX	10	TOY43TE	TP00TOYO-15.P
Voxy	04	-	TR47TK	■			Tex/Cry	TCXX	10	TOY43TE	TP00TOYO-15.P

MODEL	YEAR		KEYLINE REFERENCE	KEYLINE MICRO SERIES			TRANS. TYPE	ID	PAGE	CROSS REFERENCE OF SUBSTITUTE (WHERE AVAILABLE)	
				T	P	M					
TOYOTA JAPAN											
Wish	03	-	TR47TK	■			Tex/Cry	TCXX	10	TOY43TE	TP00TOYO-15.P
VARIOUS MAKES											
Some models	-	-	FT20TK				-	-	4	-	-
VPG											
MV-1	12	14	FD21BTK	■			Tex/Cry	TP80	3	FO38RTE	TP00FO-30D.P
VOLKSWAGEN (D)											
Amarok	10	-	V66TK			●	Meg/Cry	MG10	11	HU66TE	TP00HU-HAA.P
Beetle	98	-	V66TK			●	Meg/Cry	MG10	11	HU66TE	TP00HU-HAA.P
Bora	98	05	V66TK			●	Meg/Cry	MG10	11	HU66TE	TP00HU-HAA.P
Caravelle	04	09	V66TK			●	Meg/Cry	MG10	11	HU66TE	TP00HU-HAA.P
Crafter	06	-	V66TK			●	Meg/Cry	MG10	11	HU66TE	TP00HU-HAA.P
Cross Golf	06	-	V66TK			●	Meg/Cry	MG10	11	HU66TE	TP00HU-HAA.P
Dasher	97	97	V66TK				Ph	PH00	11	HU66TE	TP00HU-HAA.P
Dasher	98	-	V66TK			●	Meg/Cry	MG10	11	HU66TE	TP00HU-HAA.P
Eos	06	-	V66TK			●	Meg/Cry	MG10	11	HU66TE	TP00HU-HAA.P
Euro Van	00	04	V66TK			●	Meg/Cry	MG10	11	HU66TE	TP00HU-HAA.P
Fox	05	-	V66TK			●	Meg/Cry	MG10	11	HU66TE	TP00HU-HAA.P
Gol	09	-	V66TK			●	Meg/Cry	MG10	11	HU66TE	TP00HU-HAA.P
Gol	99	-	V70TK			●	Meg/Cry	MG10	11	-	TP00VO-8P
Golf	98	-	V66TK			●	Meg/Cry	MG10	11	HU66TE	TP00HU-HAA.P
Golf	98	05	V66TK			●	Meg/Cry	MG10	11	HU66TE	TP00HU-HAA.P
Golf Cabrio	04	-	V66TK			●	Meg/Cry	MG10	11	HU66TE	TP00HU-HAA.P
Individual	04	-	V66TK			●	Meg/Cry	MG10	11	HU66TE	TP00HU-HAA.P
Jetta	00	-	V66TK			●	Meg/Cry	MG10	11	HU66TE	TP00HU-HAA.P
Kombi	03	09	V66TK			●	Meg/Cry	MG10	11	HU66TE	TP00HU-HAA.P
Lavida	08	-	V66TK			●	Meg/Cry	MG10	11	HU66TE	TP00HU-HAA.P
Magotan	07	-	V66TK			●	Meg/Cry	MG10	11	HU66TE	TP00HU-HAA.P
Multivan	03	-	V66TK			●	Meg/Cry	MG10	11	HU66TE	TP00HU-HAA.P
Multivan	04	09	V66TK			●	Meg/Cry	MG10	11	HU66TE	TP00HU-HAA.P
New Beetle	98	-	V66TK			●	Meg/Cry	MG10	11	HU66TE	TP00HU-HAA.P
Parati	97	99	V66TK			●	Meg	MG00	11	HU66TE	TP00HU-HAA.P
Parati	99	-	V70TK			●	Meg/Cry	MG10	11	-	TP00VO-8P
Passat	97	98	V66TK			●	Meg	MG00	11	HU66TE	TP00HU-HAA.P
Passat	98	05	V66TK			●	Meg/Cry	MG10	11	HU66TE	TP00HU-HAA.P
Passat	06	-	V66TK			●	Meg/Cry	MG10	11	HU66TE	TP00HU-HAA.P
Polo	01	05	V66TK			●	Meg/Cry	MG10	11	HU66TE	TP00HU-HAA.P
Polo	01	-	V66TK			●	Meg/Cry	MG10	11	HU66TE	TP00HU-HAA.P
Quantum	97	98	V66TK			●	Meg	MG00	11	HU66TE	TP00HU-HAA.P
Quantum	99	-	V66TK			●	Meg/Cry	MG10	11	HU66TE	TP00HU-HAA.P
Rabbit	97	98	V66TK			●	Meg	MG00	11	HU66TE	TP00HU-HAA.P
Rabbit	99	-	V66TK			●	Meg/Cry	MG10	11	HU66TE	TP00HU-HAA.P
Sagitar	11	-	V66TK			●	Meg/Cry	MG10	11	HU66TE	TP00HU-HAA.P
Santana 2000	98	-	V66TK			●	Meg/Cry	MG10	11	HU66TE	TP00HU-HAA.P
Scirocco	08	-	V66TK			●	Meg/Cry	MG10	11	HU66TE	TP00HU-HAA.P
Sharan	95	98	V66TK				Ph	PH00	11	HU66TE	TP00HU-HAA.P
Sharan	01	06	V66TK			●	Meg/Cry	MG10	11	HU66TE	TP00HU-HAA.P
SpaceFox	05	08	V66TK			●	Meg/Cry	MG10	11	HU66TE	TP00HU-HAA.P
Tiguan	07	-	V66TK			●	Meg/Cry	MG10	11	HU66TE	TP00HU-HAA.P
Touran	03	-	V66TK			●	Meg/Cry	MG10	11	HU66TE	TP00HU-HAA.P

MODEL	YEAR	KEYLINE REFERENCE	KEYLINE MICRO SERIES			TRANS. TYPE	ID	PAGE	CROSS REFERENCE OF SUBSTITUTE (WHERE AVAILABLE)	
			T	P	M					
VOLKSWAGEN (D)										
Transporter	04	-	V66TK			● Meg/Cry	MG10	11	HU66TE	TP00HU-HAA.P
UP!	12	-	V66TK			● Meg/Cry	MG10	11	HU66TE	TP00HU-HAA.P
Vento	10	-	V66TK			● Meg/Cry	MG10	11	HU66TE	TP00HU-HAA.P
Voyage	09	-	V66TK			● Meg/Cry	MG10	11	HU66TE	TP00HU-HAA.P
VOLKSWAGEN S. AMERICA										
Crossfox	10	-	V66TK			● Meg/Cry	MG10	11	HU66TE	TP00HU-HAA.P
Sportvan	06	10	HD1BTK			● Meg/Cry	MG10	4	HON66TE	TP00HOND-31.P
Suran	06	10	V66TK			● Meg/Cry	MG10	11	HU66TE	TP00HU-HAA.P
YAMAHA (J)										
BT1100 Bulldog	05	-	YM35TK	■		Tex/Cry	TCXX	12	YH35RATE	-
Fazer 8	10	-	YM35TK	■		Tex/Cry	TPXX	12	YH35RATE	-
FJ-09	15	-	YM35TK	■		Tex/Cry	TPXX	12	YH35RATE	-
FJR1300	05	-	YM35TK	■		Tex/Cry	TC01	12	YH35RATE	-
FZ-07	13	-	YM35TK	■		Tex/Cry	TPXX	12	YH35RATE	-
FZ-09	13	-	YM35TK	■		Tex/Cry	TPXX	12	YH35RATE	-
FZ1	06	-	YM35TK	■		Tex/Cry	TC01	12	YH35RATE	-
FZ1 Fazer	06	-	YM35TK	■		Tex/Cry	TPXX	12	YH35RATE	-
FZ6	04	-	YM35TK	■		Tex/Cry	TC01	12	YH35RATE	-
FZ8	10	-	YM35TK	■		Tex/Cry	TC01	12	YH35RATE	-
FZS1000 Fazer	05	-	YM35TK	■		Tex/Cry	TC01	12	YH35RATE	-
Majesty 400	04	-	YM35TK	■		Tex/Cry	TC01	12	YH35RATE	-
MT-01 / MT-03	04	-	YM35TK	■		Tex/Cry	TC01	12	YH35RATE	-
MT-07	13	-	YM35TK	■		Tex/Cry	TPXX	12	YH35RATE	-
MT-09	13	-	YM35TK	■		Tex/Cry	TPXX	12	YH35RATE	-
MT-09 Tracer	15	-	YM35TK	■		Tex/Cry	TPXX	12	YH35RATE	-
TDM600	05	-	YM35TK	■		Tex/Cry	TC01	12	YH35RATE	-
TDM900	10	-	YM35TK	■		Tex/Cry	TPXX	12	YH35RATE	-
T-Max	05	-	YM35TK	■		Tex/Cry	TC01	12	YH35RATE	-
VMAX	09	-	YM35TK	■		Tex/Cry	TPXX	12	YH35RATE	-
X-City 125	07	-	YM35TK	■		Tex/Cry	TPXX	12	YH35RATE	-
XJ6 Diversion	09	-	YM35TK	■		Tex/Cry	TPXX	12	YH35RATE	-
XJR 1300	04	-	YM35TK	■		Tex/Cry	TC01	12	YH35RATE	-
X-Max 125	06	-	YM35TK	■		Tex/Cry	TCXX	12	YH35RATE	-
X-Max 250	06	-	YM35TK	■		Tex/Cry	TPXX	12	YH35RATE	-
XT 600 Tenerè	08	-	YM35TK	■		Tex/Cry	TCXX	12	YH35RATE	-
XT1200Z Super Ténére	10	-	YM35TK	■		Tex/Cry	TC01	12	YH35RATE	-
XT660	04	-	YM35TK	■		Tex/Cry	TPXX	12	YH35RATE	-
XT660Z Ténére	07	-	YM35TK	■		Tex/Cry	TC01	12	YH35RATE	-
XTR	04	-	YM35TK	■		Tex/Cry	TCXX	12	YH35RATE	-
XTX	04	-	YM35TK	■		Tex/Cry	TCXX	12	YH35RATE	-
XV1900A	09	-	YM35TK	■		Tex/Cry	TPXX	12	YH35RATE	-
XVS 1100 DragStar	03	-	YM35TK	■		Tex/Cry	TC01	12	YH35RATE	-
XVS 650 DragStar	04	-	YM35TK	■		Tex/Cry	TCXX	12	YH35RATE	-
XVS950A	09	-	YM35TK	■		Tex/Cry	TPXX	12	YH35RATE	-
YZF-R1	05	-	YM35TK	■		Tex/Cry	TCXX	12	YH35RATE	-
YZF-R6	03	-	YM35TK	■		Tex/Cry	TC01	12	YH35RATE	-



A BIANCHI 1770 GROUP COMPANY

POD KEYS DI VECCHIA GENERAZIONE

OLD GENERATION POD KEYS

POD KEYS DER ALTEN GENERATION

POD KEYS DE VIEILLE GÉNÉRATION

POD KEYS DE VIEJA GENERACIÓN



BIANCHI 1770 GROUP

Innovators by design | Since 1770



AD35

AD66

AR16

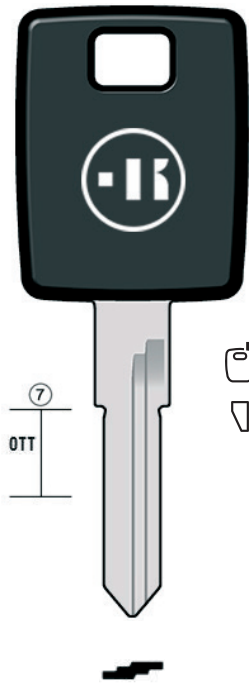

AD35TK-1*

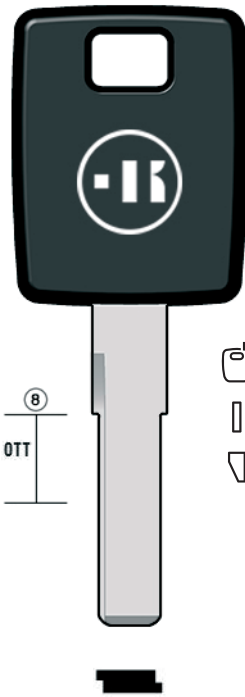

AD66TK-1*
AD66TK-8

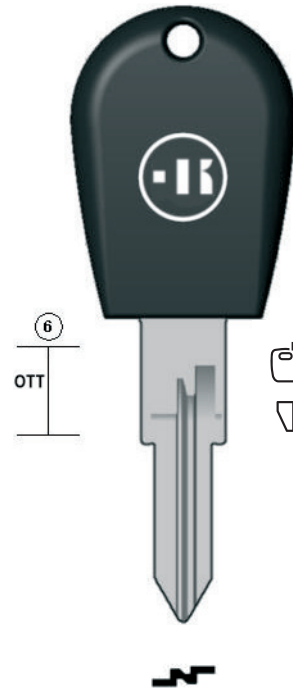

AR16TK-1*

AR1505

DAE46

DAE46S

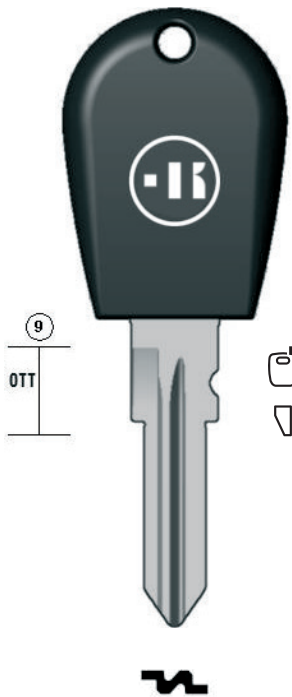

AR1505TK-1*

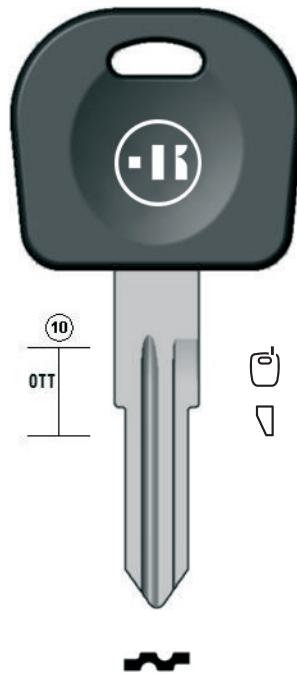

DAE46TK-1*

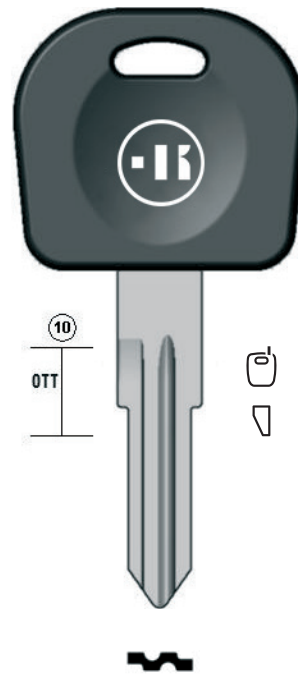

DAE46STK-1*

* Discontinued transponder: Keyline doesn't supply this code anymore.

* Transponder discontinuato: Keyline non fornisce più questo codice.

DAE47S

DAE48

DAE48S

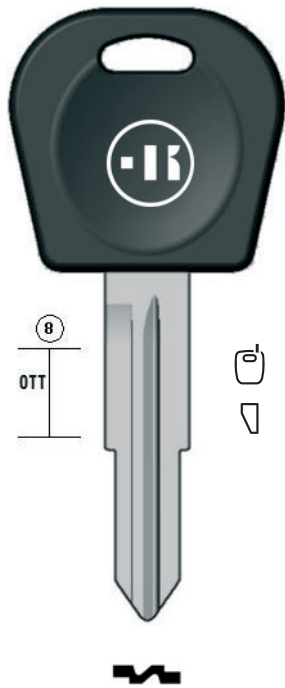

DAE47STK-1*

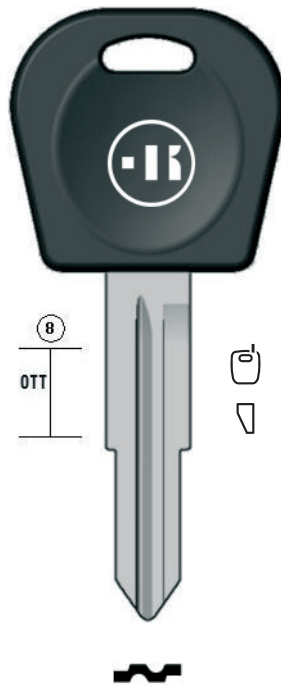

DAE48TK-1*

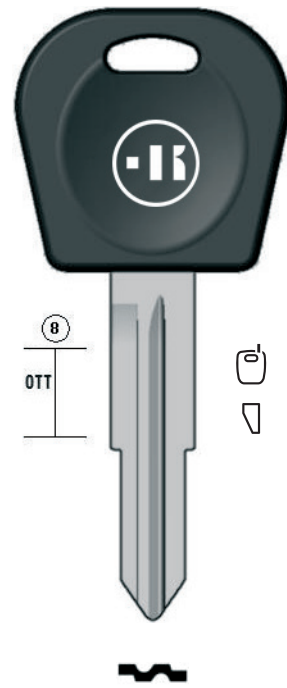

DAE48STK-1*

DAI4S

FD1

FD40

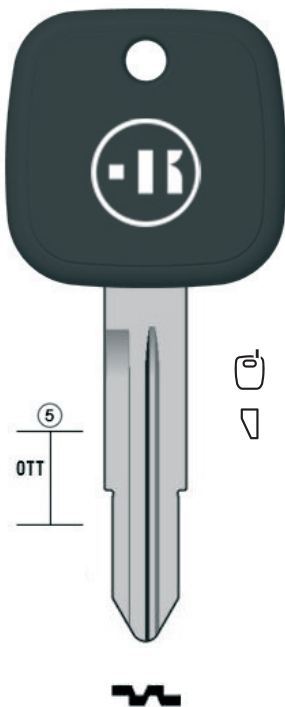

DAI4STK-3

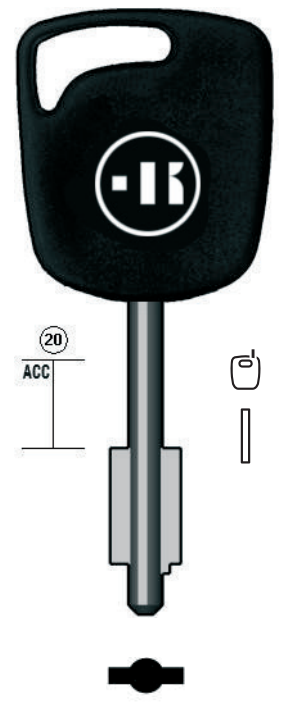

FD1TK-2
FD1TK-7

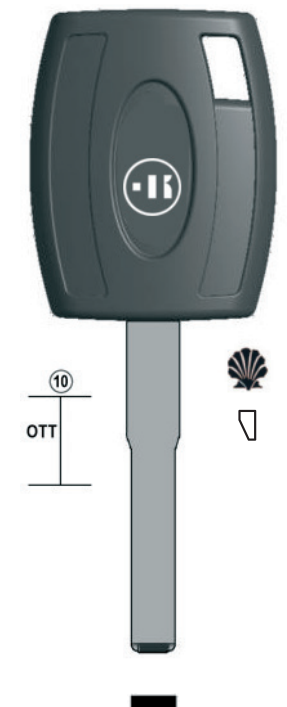

FD40TK-14

* Discontinued transponder: Keyline doesn't supply this code anymore.

* Transponder discontinuato: Keyline non fornisce più questo codice.

FD66

FT50A

FT1505

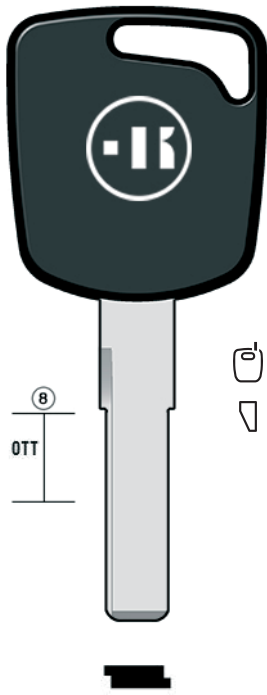

FD66TK-1*

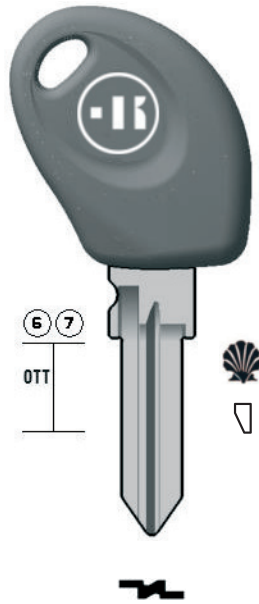

FT50ATK-5

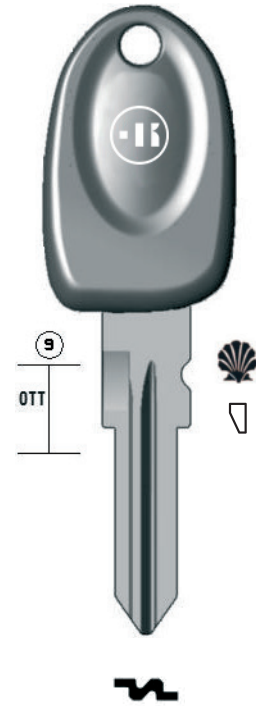

FT1505TK-5

FT1505A

FT1505B

JA2

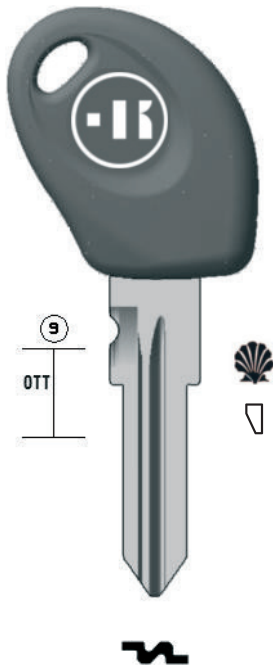

FT1505ATK-5

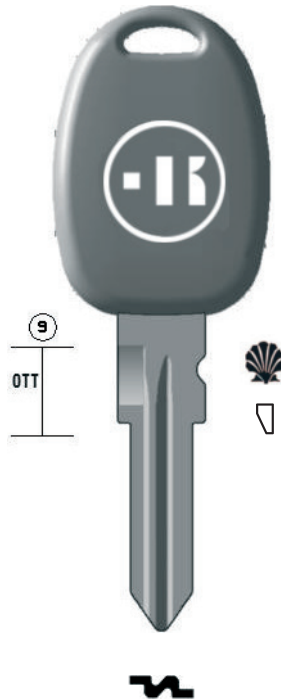

FT1505BTK-5



JA2TK-7

* Discontinued transponder: Keyline doesn't supply this code anymore.

* Transponder discontinuato: Keyline non fornisce più questo codice.

KI4

LA1505

MZ23

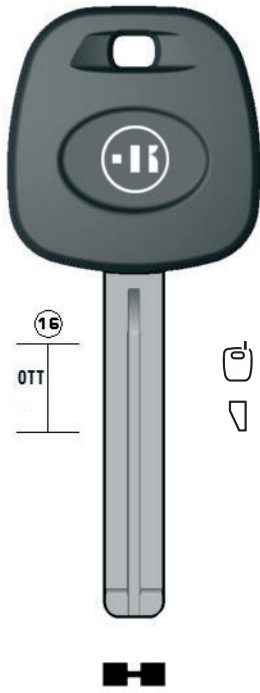

KI4TK-13

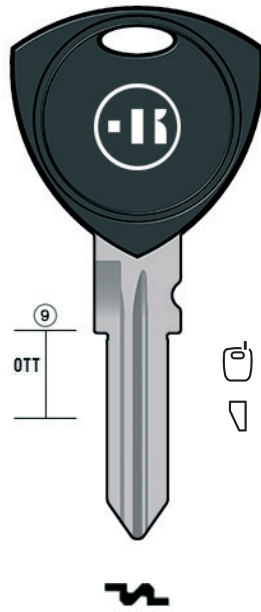

LA1505TK-5**

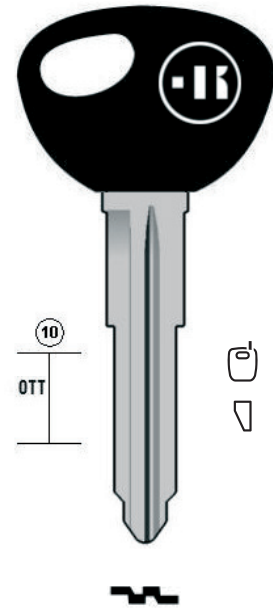

MZ23TK-5

MZ27

NS2

NS3

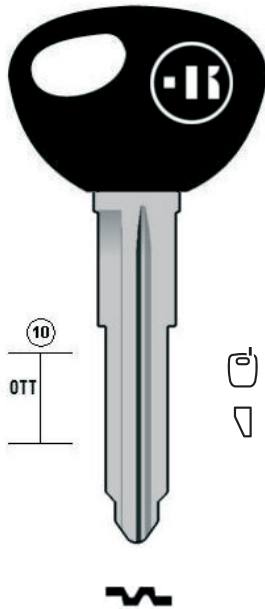

MZ27TK-5

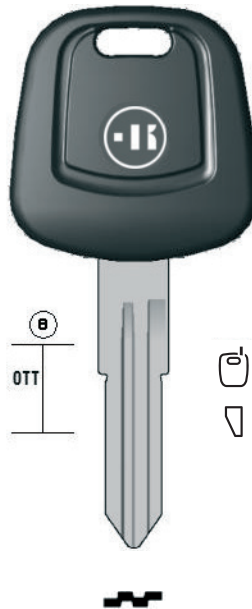

NS2TK-1*
NS2TK-11
NS2TK-13

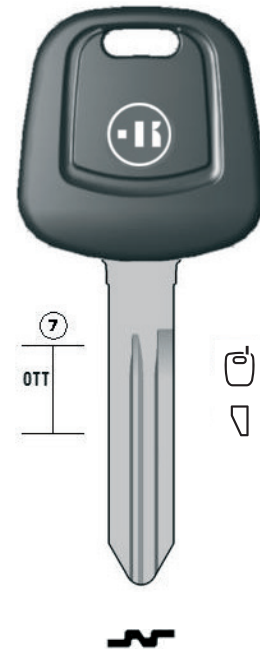

NS3TK-1*
NS3TK-11
NS3TK-13

* Discontinued transponder: Keyline doesn't supply this code anymore.
** Discontinued product: Keyline doesn't supply this article anymore.

* Transponder discontinuato: Keyline non fornisce più questo codice.
** Prodotto discontinuato: Keyline non fornisce più questo articolo.

PG30L

PG31

RV3

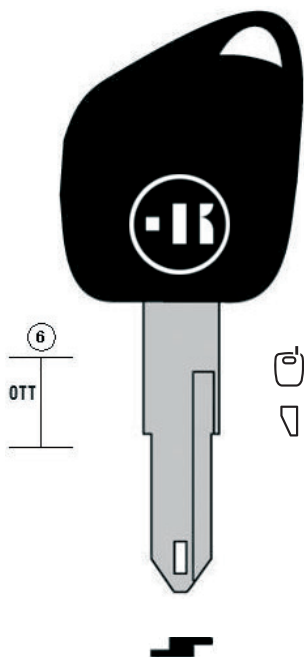

PG30LTK-1*

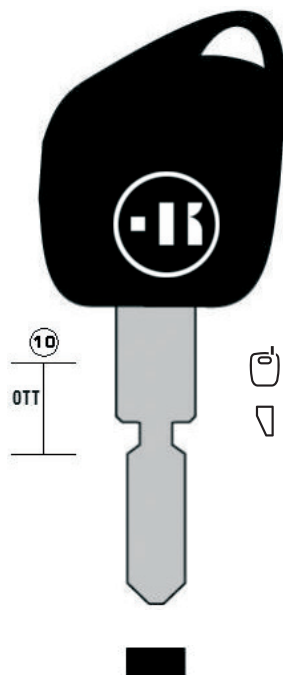

PG31TK-1*

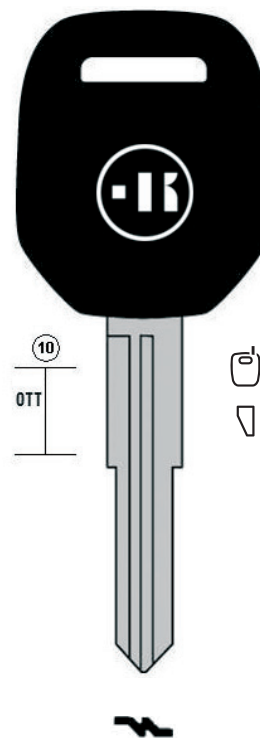

RV3TK-1*

SK21S

TR12

V35

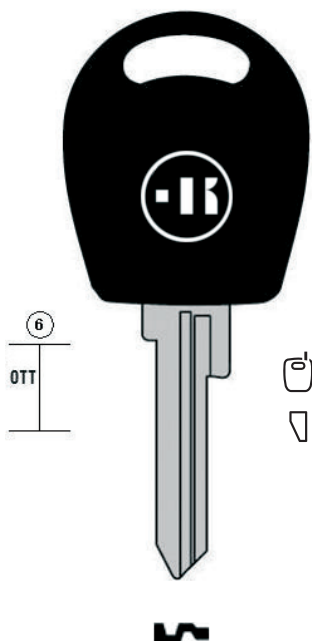

SK21STK-1*

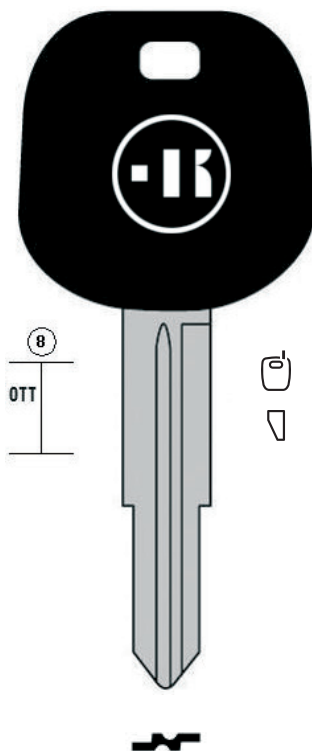

TR12TK-5

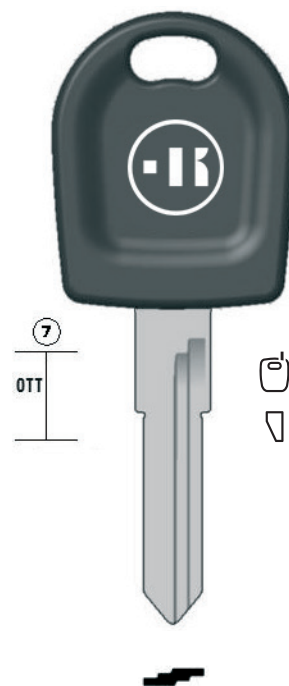

V35TK-1*
V35TK-10

* Discontinued transponder: Keyline doesn't supply this code anymore.

* Transponder discontinuato: Keyline non fornisce più questo codice.

V35S

VL10

VL15

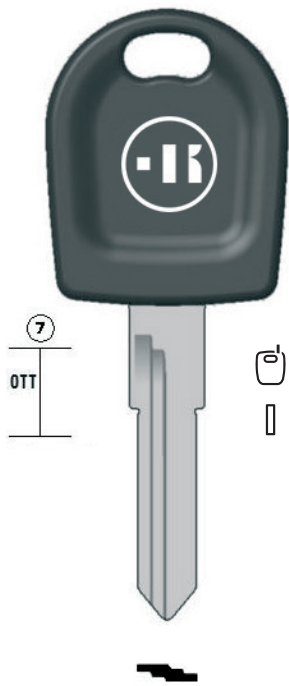

V35STK-8

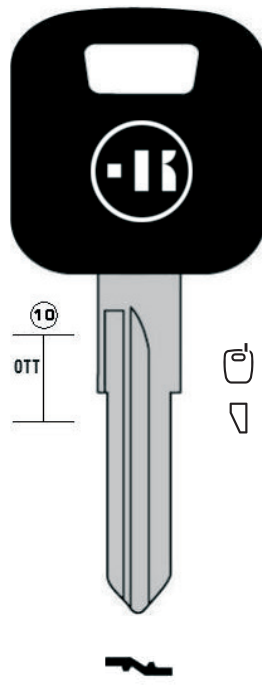

VL10TK-1*

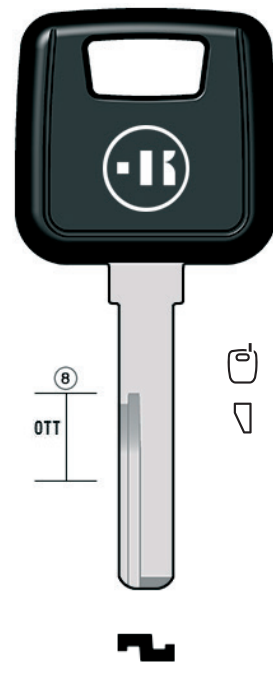

VL15TK-1*

VL17

VX1

VX2

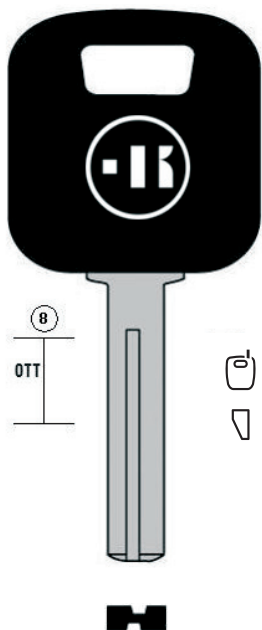

VL17TK-1*

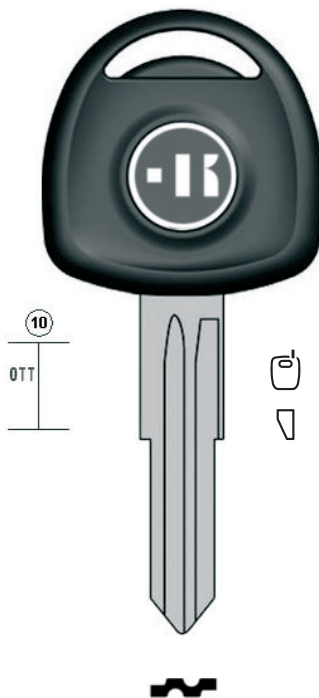

VX1TK-1*
VX1TK-9
VX1TK-12

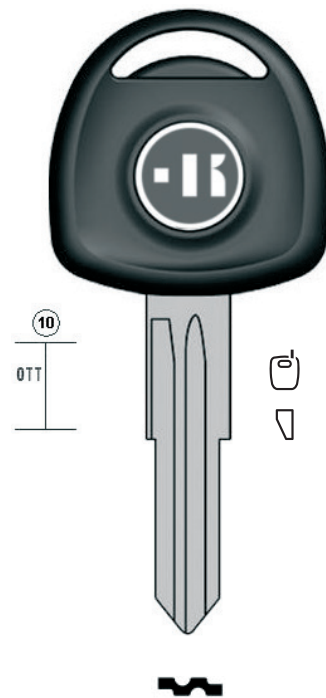

VX2TK-1*
VX2TK-9

* Discontinued transponder: Keyline doesn't supply this code anymore.

* Transponder discontinuato: Keyline non fornisce più questo codice.

VX3

VX4

VX5

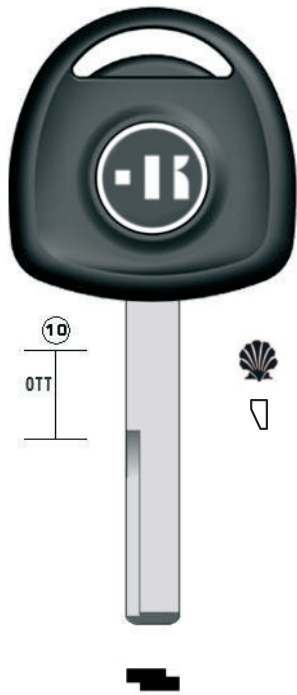

VX3TK-5

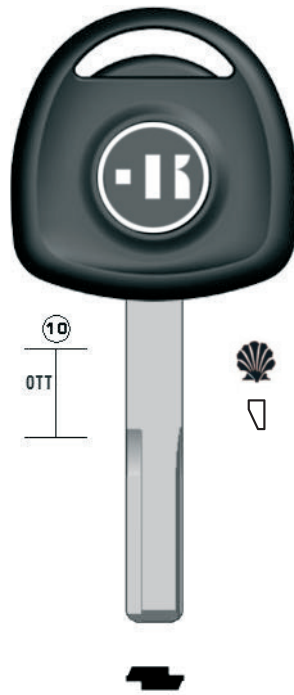

VX4TK-5
VX4TK-12



VX5TK-12

YS15

ZAD18

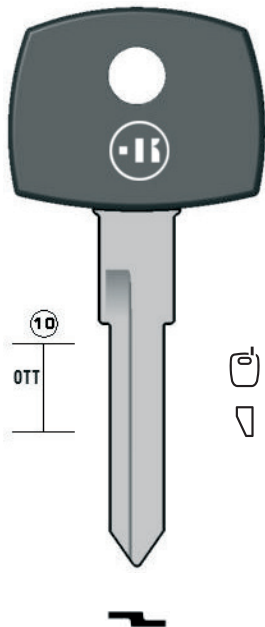

YS15TK-1*

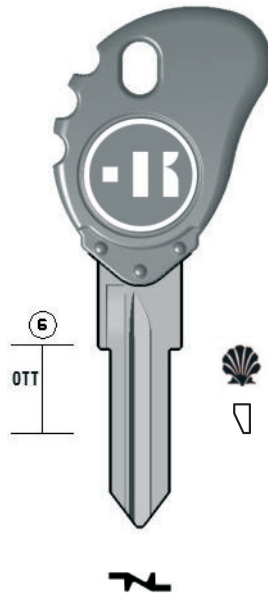

ZAD18TK-5

* Discontinued transponder: Keyline doesn't supply this code anymore.

* Transponder discontinuato: Keyline non fornisce più questo codice.

INDEX - INDICE

MODEL	YEAR		KEYLINE REFERENCE	KEYLINE MICRO SERIES			TRANS. TYPE	ID	PAGE	CROSS REFERENCE OF SUBSTITUTE (WHERE AVAILABLE)	
				T	P	M					
ALFA ROMEO (I)											
145	95	98	AR1505TK-1*				Ph	PH00	42	GT15RT2	TP05FI-13.P3
146	95	98	AR1505TK-1*				Ph	PH00	42	GT15RT2	TP05FI-13.P3
155	95	98	AR1505TK-1*				Ph	PH00	42	GT15RT2	TP05FI-13.P3
164	95	98	AR16TK-1*				Ph	PH00	42	GT16T2	TP01AF-14P
GTV	95	98	AR1505TK-1*				Ph	PH00	42	GT15RT2	TP05FI-13.P3
Spider	95	98	AR1505TK-1*				Ph	PH00	42	GT15RT2	TP05FI-13.P3
APRILIA (I)											
Atlantic 500	03	-	ZAD18TK-5				Temic	TM20	48	ZD24RT5	TP05ZA-11P
Dorsoduro 1200	11	-	ZAD18TK-5				Temic	TM20	48	ZD24RT5	TP05ZA-11P
Mana 850	08	-	ZAD18TK-5				Temic	TM20	48	ZD24RT5	TP05ZA-11P
Scarabeo 500	03	-	ZAD18TK-5				Temic	TM20	48	ZD24RT5	TP05ZA-11P
Shiver 750	10	-	ZAD18TK-5				Temic	TM20	48	ZD24RT5	TP05ZA-11P
AUDI (D)											
80/90	95	97	AD35TK-1*			●	Meg	MG00	42	HU49AT5	TP05AU-AH.P2
A1	10	-	AD66TK-8			●	Meg/Cry	MG10	42	HU66AT6	TP05HU-HAA.P
A2	00	05	AD66TK-8			●	Meg/Cry	MG10	42	HU66AT6	TP05HU-HAA.P
A3	96	97	AD66TK-1*			●	Meg	MG00	42	HU66AT5	TP05HU-HAA.P
A3	97	04	AD66TK-8			●	Meg/Cry	MG10	42	HU66AT6	TP05HU-HAA.P
A4	95	96	AD35TK-1*			●	Meg	MG00	42	HU49AT5	TP05AU-AH.P2
A4	96	97	AD66TK-1*			●	Meg	MG00	42	HU66AT5	TP05HU-HAA.P
A4	97	04	AD66TK-8			●	Meg/Cry	MG10	42	HU66AT6	TP05HU-HAA.P
A4	04	07	AD66TK-8			●	Meg/Cry	MG10	42	HU66AT6	TP05HU-HAA.P
A6	95	96	AD35TK-1*			●	Meg	MG00	42	HU49AT5	TP05AU-AH.P2
A6	96	97	AD66TK-1*			●	Meg	MG00	42	HU66AT5	TP05HU-HAA.P
A6	97	05	AD66TK-8			●	Meg/Cry	MG10	42	HU66AT6	TP05HU-HAA.P
A8	95	96	AD35TK-1*			●	Meg	MG00	42	HU49AT5	TP05AU-AH.P2
A8	96	97	AD66TK-1*			●	Meg	MG00	42	HU66AT5	TP05HU-HAA.P
A8	97	04	AD66TK-8			●	Meg/Cry	MG10	42	HU66AT6	TP05HU-HAA.P
Allroad	00	05	AD66TK-8			●	Meg/Cry	MG10	42	HU66AT6	TP05HU-HAA.P
Cabrio	95	96	AD35TK-1*			●	Meg	MG00	42	HU49AT5	TP05AU-AH.P2
Cabrio	96	97	AD66TK-1*			●	Meg	MG00	42	HU66AT5	TP05HU-HAA.P
Cabrio	97	-	AD66TK-8			●	Meg/Cry	MG10	42	HU66AT6	TP05HU-HAA.P
Coupé	95	96	AD35TK-1*			●	Meg	MG00	42	HU49AT5	TP05AU-AH.P2
Coupé	96	97	AD66TK-1*			●	Meg	MG00	42	HU66AT5	TP05HU-HAA.P
Coupé	97	-	AD66TK-8			●	Meg/Cry	MG10	42	HU66AT6	TP05HU-HAA.P
S2	95	96	AD35TK-1*			●	Meg	MG00	42	HU49AT5	TP05AU-AH.P2
S2	96	97	AD66TK-1*			●	Meg	MG00	42	HU66AT5	TP05HU-HAA.P
S2	97	-	AD66TK-8			●	Meg/Cry	MG10	42	HU66AT6	TP05HU-HAA.P
S3	01	-	AD66TK-8			●	Meg/Cry	MG10	42	HU66AT6	TP05HU-HAA.P
S4	02	-	AD66TK-8			●	Meg/Cry	MG10	42	HU66AT6	TP05HU-HAA.P
S6	95	96	AD35TK-1*			●	Meg	MG00	42	HU49AT5	TP05AU-AH.P2
S6	96	97	AD66TK-1*			●	Meg	MG00	42	HU66AT5	TP05HU-HAA.P
S6	97	-	AD66TK-8			●	Meg/Cry	MG10	42	HU66AT6	TP05HU-HAA.P
S8	98	-	AD66TK-8			●	Meg/Cry	MG10	42	HU66AT6	TP05HU-HAA.P

MODEL	YEAR		KEYLINE REFERENCE	KEYLINE MICRO SERIES			TRANS. TYPE	ID	PAGE	CROSS REFERENCE OF SUBSTITUTE (WHERE AVAILABLE)	
				T	P	M					
AUDI (D)											
TT	98	04	AD66TK-8			●	Meg/Cry	MG10	42	HU66AT6	TP05HU-HAA.P
CADILLAC (USA)											
Catera	97	99	VX1TK-1*				Ph	PH00	47	HU46T2	TP05OP-SP
CHEVROLET (EUR)											
Aveo	06	11	DAE48STK-1*			●	Meg/Cry	MG10	43	DWO4RT5	TP05DAE-3D.P1
Kalos	02	06	DAE48STK-1*			●	Meg/Cry	MG10	43	DWO4RT5	TP05DAE-3D.P1
Lacetti	02	04	DAE48STK-1*			●	Meg/Cry	MG10	43	DWO4RT5	TP05DAE-3D.P1
Nubira	00	02	DAE48STK-1*			●	Meg/Cry	MG10	43	DWO4RT5	TP05DAE-3D.P1
Tacuma	00	08	DAE48STK-1*			●	Meg/Cry	MG10	43	DWO4RT5	TP05DAE-3D.P1
CHEVROLET (USA)											
Avalanche	07	08	DAE48STK-1*			●	Meg/Cry	MG10	43	DWO4RT5	TP05DAE-3D.P1
Aveo	04	10	DAE48STK-1*			●	Meg	MG00	43	DWO4RT5	TP05DAE-3D.P1
Colorado	08	11	DAE48STK-1*			●	Meg/Cry	MG10	43	DWO4RT5	TP05DAE-3D.P1
Tacuma	00	08	DAE48STK-1*			●	Meg/Cry	MG10	43	DWO4RT5	TP05DAE-3D.P1
Vivant	04	07	DAE47STK-1*			●	Meg	MG00	43	DWO5RT5	-
CITROËN (F)											
Jumper	96	01	FT50ATK-5			●	Meg	MG00	44	GT10BT5	-
Relay	96	01	FT50ATK-5			●	Meg	MG00	44	GT10BT5	-
DAEWOO (ROK)											
Espero	95	-	DAE46TK-1*			●	Meg	MG00	42	HU46AT5	-
Espero	95	-	DAE46STK-1*			●	Meg	MG00	42	-	-
Kalos	02	06	DAE48STK-1*			●	Meg/Cry	MG10	43	DWO4RT5	TP05DAE-3D.P1
Lanos	97	02	DAE47STK-1*			●	Meg	MG00	43	DWO5RT5	-
Lanos	02	04	DAE47STK-1*			●	Meg/Cry	MG10	43	DWO5RT5	-
Leganza	00	08	DAE47STK-1*			●	Meg/Cry	MG10	43	DWO5RT5	-
Matiz	06	-	DAE48TK-1*			●	Meg/Cry	MG10	43	DWO4T5	-
Nexia	95	97	DAE46STK-1*			●	Meg	MG00	42	-	-
Nexia	95	97	DAE46TK-1*			●	Meg	MG00	42	HU46AT5	-
Nubira	97	00	DAE48STK-1*			●	Meg	MG00	43	DWO4RT5	TP05DAE-3D.P1
Nubira	97	00	DAE48TK-1*			●	Meg	MG00	43	DWO4T5	-
Nubira	00	02	DAE48STK-1*			●	Meg/Cry	MG10	43	DWO4RT5	TP05DAE-3D.P1
Nubira	02	08	DAE48TK-1*			●	Meg/Cry	MG10	43	DWO4T5	-
Tacuma	00	08	DAE48STK-1*			●	Meg/Cry	MG10	43	DWO4RT5	TP05DAE-3D.P1
DAIHATSU (J)											
Aranos	95	97	DAE46TK-1*			●	Meg	MG00	42	HU46AT5	-
Cuore	98	06	DAI4STK-3	■			Tex	TX00	43	DH5RT4	-
Move	97	02	DAI4STK-3	■			Tex	TX00	43	DH5RT4	-
FIAT (I)											
Barchetta	95	02	FT1505TK-5			●	Meg	MG00	44	GT15RAT5	TP05FI-13P2
Brava	95	96	FT1505ATK-5			●	Meg	MG00	44	GT15RBT5	TP05FI-13P5
Brava	97	01	FT1505BTK-5				Temic	TM10	44	GT15RCT5	TP05FI-13P7
Bravo	95	96	FT1505ATK-5			●	Meg	MG00	44	GT15RBT5	TP05FI-13P5
Bravo	97	01	FT1505BTK-5				Temic	TM10	44	GT15RCT5	TP05FI-13P7
Cinquecento	95	96	FT50ATK-5			●	Meg	MG00	44	GT10BT5	-
Cinquecento	97	98	FT1505ATK-5			●	Meg	MG00	44	GT15RBT5	TP05FI-13P5
Coupè	95	00	FT1505TK-5				Ph	PH00	44	GT15RAT5	TP05FI-13P2
Croma	95	97	FT50ATK-5				Ph	PH00	44	GT10BT5	-
Ducato	96	01	FT50ATK-5			●	Meg	MG00	44	GT10BT5	-
Fiorino	95	02	FT50ATK-5				Temic	TM10	44	GT10BT5	-

MODEL	YEAR		KEYLINE REFERENCE	KEYLINE MICRO SERIES			TRANS. TYPE	ID	PAGE	CROSS REFERENCE OF SUBSTITUTE (WHERE AVAILABLE)	
				T	P	M					
FIAT (I)											
Marea	96	02	FT1505BTK-5				Temic	TM10	44	GT15RCT5	TP05FI-13P7
Marengo	96	-	FT1505ATK-5			●	Meg	MG00	44	GT15RBT5	TP05FI-13P5
Palio	96	01	FT1505BTK-5				Temic	TM10	44	GT15RCT5	TP05FI-13P7
Panda	95	02	FT50ATK-5			●	Meg	MG00	44	GT10BT5	-
Punto	95	99	FT1505TK-5			●	Meg	MG00	44	GT15RAT5	TP05FI-13P2
Seicento	95	96	FT50ATK-5			●	Meg	MG00	44	GT10BT5	-
Seicento	97	00	FT1505ATK-5			●	Meg	MG00	44	GT15RBT5	TP05FI-13P5
Tempra	95	96	FT1505ATK-5			●	Meg	MG00	44	GT15RBT5	TP05FI-13P5
FORD (AUS)											
Falcon	05	-	FD40TK-14	■			Tex/Cry	TP01	43	HU101T17	TP20FO-24P
FORD (EU)											
C-Max	03	10	FD40TK-14	■			Tex/Cry	TP01	43	HU101T17	TP20FO-24P
Focus	04	10	FD40TK-14	■			Tex/Cry	TP01	43	HU101T17	TP20FO-24P
Galaxy	95	97	FD66TK-1*				Ph	PH00	44	HU66BT1	-
Maverick	95	-	NS2TK-1*				Ph	PH00	45	NSN11T2	TP05DAT-6P2
Mondeo	07	-	FD40TK-14	■			Tex/Cry	TCXX	43	HU101T17	TP20FO-24P
Probe	96	-	MZ23TK-5				Temic	TM10	45	MAZ13T5	TP04MAZ-10DP
S-Max	06	-	FD40TK-14	■			Tex/Cry	TP01	43	HU101T17	TP20FO-24P
GM (BR)											
Corsa	98	99	VX1TK-9				Ph/Cry	PH1A	47	HU46T9	-
Corsa	98	99	VX1TK-1*				Ph/Cry	PH1A	47	HU46T2	TP05OP-SP
Zafira	99	00	VX1TK-1*				Ph/Cry	PH1A	47	HU46T2	TP05OP-SP
Zafira	99	00	VX1TK-9				Ph/Cry	PH1A	47	HU46T9	-
HOLDEN (AUS)											
Astra	95	98	VX1TK-1*				Ph	PH00	47	HU46T2	TP05OP-SP
Astra	98	01	VX1TK-9				Ph/Cry	PH1A	47	HU46T9	-
Astra	98	01	VX1TK-1*				Ph/Cry	PH1A	47	HU46T2	TP05OP-SP
Astra	01	04	VX1TK-1*				Ph/Cry	PH1A	47	HU46T2	TP05OP-SP
Astra	01	04	VX1TK-9				Ph/Cry	PH1A	47	HU46T9	-
Barina	95	98	VX1TK-1*				Ph	PH00	47	HU46T2	TP05OP-SP
Barina	98	06	VX1TK-1*				Ph/Cry	PH1A	47	HU46T2	TP05OP-SP
Barina	98	06	VX1TK-9				Ph/Cry	PH1A	47	HU46T9	-
Barina	04	06	VX5TK-12				Ph/Cry	PH1A	48	HU100T2	-
Barina	06	-	DAE48STK-1*			●	Meg/Cry	MG10	43	DWO4RT5	TP05DAE-3D.P1
Combo	98	-	VX1TK-1*				Ph	PH00	47	HU46T2	TP05OP-SP
Vectra	95	98	VX1TK-1*				Ph	PH00	47	HU46T2	TP05OP-SP
Vectra	98	04	VX4TK-12				Ph/Cry	PH1A	48	HU43T9	TP09OP-WHP
HONDA (J)											
Accord	95	99	RV3TK-1*				Ph	PH00	46	NE77RT2	TP05NE-35.P3
HYUNDAI (ROK)											
Azera	06	10	KI4TK-13			▲	Ph/Cry	PH20	45	-	-
INFINITI (J)											
i30	95	99	NS2TK-1*				Ph	PH00	45	NSN11T2	TP05DAT-6P2
Q45	95	97	NS3TK-1*				Ph	PH00	45	NSN14T5	-
QX4	95	98	NS3TK-1*				Ph	PH00	45	NSN14T5	-
JAGUAR (GB)											
Some models	96	-	JA2TK-7	■			Tex/Cry	TC01	44	-	-
XJ8	00	03	JA2TK-7			●	Meg/Cry	MG10	44	-	-
XJR	00	03	JA2TK-7			●	Meg/Cry	MG10	44	-	-

MODEL	YEAR		KEYLINE REFERENCE	KEYLINE MICRO SERIES			TRANS. TYPE	ID	PAGE	CROSS REFERENCE OF SUBSTITUTE (WHERE AVAILABLE)	
				T	P	M					
JAGUAR (GB)											
XK8	00	06	JA2TK-7			●	Meg/Cry	MG10	44	-	-
XKR	00	06	JA2TK-7			●	Meg/Cry	MG10	44	-	-
X-Type	02	-	JA2TK-7	■			Tex/Cry	TC01	44	-	-
KIA (ROK)											
Amanti	04	-	KI4TK-13	■			Tex/Cry	TCXX	45	-	-
LANCIA (I)											
Dedra	95	97	LA1505TK-5**			●	Meg	MG00	45	GT18RT5	TP01FI-134
Dedra	98	-	LA1505TK-5**				Temic	TM10	45	GT18RT5	TP01FI-134
Delta	95	99	LA1505TK-5**			●	Meg	MG00	45	GT18RT5	TP01FI-134
Y	96	03	LA1505TK-5**				Temic	TM10	45	GT18RT5	TP01FI-134
LDV (GB)											
Convoy	98	00	FD1TK-2	■			Tex	TX00	43	-	-
Convoy	00	-	FD1TK-7	■			Tex/Cry	TC01	43	-	-
Cub	98	00	FD1TK-2	■			Tex	TX00	43	-	-
Cub	00	-	FD1TK-7	■			Tex/Cry	TC01	43	-	-
MAZDA (EU)											
323	95	97	MZ23TK-5				Temic	TM20	45	MAZ13T5	TP04MAZ-10DP
626	95	99	MZ27TK-5				Temic	TM20	45	MAZ20RT5	TP04MAZ-9DP
MX-3	95	-	MZ23TK-5				Temic	TM20	45	MAZ13T5	TP04MAZ-10DP
MX-5	95	97	MZ23TK-5				Temic	TM20	45	MAZ13T5	TP04MAZ-10DP
MX-6	95	-	MZ27TK-5				Temic	TM20	45	MAZ20RT5	TP04MAZ-9DP
Xedos 6	95	99	MZ27TK-5				Temic	TM20	45	MAZ20RT5	TP04MAZ-9DP
MBK (I)											
Booster	98	-	ZAD18TK-5				Temic	TM10	48	ZD24RT5	TP05ZA-11P
CT 50	95	-	ZAD18TK-5				Temic	TM10	48	ZD24RT5	TP05ZA-11P
Doodo	95	-	ZAD18TK-5				Temic	TM10	48	ZD24RT5	TP05ZA-11P
Fizz	95	-	ZAD18TK-5				Temic	TM10	48	ZD24RT5	TP05ZA-11P
Flipper	95	-	ZAD18TK-5				Temic	TM10	48	ZD24RT5	TP05ZA-11P
New Flame	95	-	ZAD18TK-5				Temic	TM10	48	ZD24RT5	TP05ZA-11P
New Sorriso	95	-	ZAD18TK-5				Temic	TM10	48	ZD24RT5	TP05ZA-11P
Nitro	95	-	ZAD18TK-5				Temic	TM10	48	ZD24RT5	TP05ZA-11P
Ovetto	98	-	ZAD18TK-5				Temic	TM10	48	ZD24RT5	TP05ZA-11P
Skyliner	95	-	ZAD18TK-5				Temic	TM10	48	ZD24RT5	TP05ZA-11P
Stunt Cat	95	-	ZAD18TK-5				Temic	TM10	48	ZD24RT5	TP05ZA-11P
Target	95	-	ZAD18TK-5				Temic	TM10	48	ZD24RT5	TP05ZA-11P
Thunder	95	-	ZAD18TK-5				Temic	TM10	48	ZD24RT5	TP05ZA-11P
XC 125	95	-	ZAD18TK-5				Temic	TM10	48	ZD24RT5	TP05ZA-11P
XC 150	95	-	ZAD18TK-5				Temic	TM10	48	ZD24RT5	TP05ZA-11P
MERCEDES (D)											
Actros	97	98	YS15TK-1*			●	Meg	MG00	48	YM15T5	TP04ME-HMP1
Actros	99	-	YS15TK-1*				Temic	TM10	48	YM15T5	TP04ME-HMP1
Sprinter	97	-	YS15TK-1*				Temic	TM10	48	YM15T5	TP04ME-HMP1
Vito	98	99	YS15TK-1*			●	Meg	MG00	48	YM15T5	TP04ME-HMP1
Vito	00	-	YS15TK-1*				Temic	TM10	48	YM15T5	TP04ME-HMP1
MITSUBISHI (J)											
Carisma	96	00	VL15TK-1*				Ph	PH00	47	HU56RAT2	TP05HU-DH.P1
NISSAN (J)											
Almera	95	98	NS2TK-1*				Ph	PH00	45	NSN11T2	TP05DAT-6P2
Almera	99	00	NS3TK-11			▲	Ph/Cry	PH1B	45	NSN14T11	TP13DAT-15.P2

MODEL	YEAR	KEYLINE REFERENCE	KEYLINE MICRO SERIES			TRANS. TYPE	ID	PAGE	CROSS REFERENCE OF SUBSTITUTE (WHERE AVAILABLE)	
			T	P	M					
NISSAN (J)										
Almera	00	-	NS3TK-13	■		Tex/Cry	TC07	45	NSN14T13	TP19DAT-6.P2
Almera Tino	99	04	NS3TK-13	■		Tex/Cry	TC07	45	NSN14T13	TP19DAT-6.P2
Atleon	02	-	NS2TK-13	■		Tex/Cry	TC07	45	NSN11T13	-
Cab Star	00	-	NS2TK-13	■		Tex/Cry	TC07	45	NSN11T13	-
Maxima	95	99	NS2TK-1*			Ph	PH00	45	NSN11T2	TP05DAT-6P2
Maxima	00	03	NS2TK-13	■		Tex/Cry	TC07	45	NSN11T13	-
Maxima	00	03	NS2TK-11		▲	Ph/Cry	PH1B	45	NSN11T11	-
Micra	96	98	NS2TK-1*			Ph	PH00	45	NSN11T2	TP05DAT-6P2
Micra	99	00	NS2TK-11		▲	Ph/Cry	PH1B	45	NSN11T11	-
Micra	01	03	NS2TK-13	■		Tex/Cry	TC07	45	NSN11T13	-
Navara	03	-	NS3TK-13	■		Tex/Cry	TC07	45	NSN14T13	TP19DAT-6.P2
Patrol	98	03	NS3TK-11		▲	Ph/Cry	PH1B	45	NSN14T11	TP13DAT-15.P2
Patrol	04	-	NS3TK-13	■		Tex/Cry	TC07	45	NSN14T13	TP19DAT-6.P2
Primera	95	96	NS2TK-1*			Ph	PH00	45	NSN11T2	TP05DAT-6P2
Primera	97	97	NS3TK-1*			Ph	PH00	45	NSN14T5	-
Primera	98	00	NS3TK-13	■		Tex/Cry	TC07	45	NSN14T13	TP19DAT-6.P2
Primera	01	02	NS3TK-11		▲	Ph/Cry	PH1B	45	NSN14T11	TP13DAT-15.P2
Pulsar	95	96	NS2TK-1*			Ph	PH00	45	NSN11T2	TP05DAT-6P2
Pulsar	97	98	NS3TK-1*			Ph	PH00	45	NSN14T5	-
Pulsar	99	00	NS3TK-13	■		Tex/Cry	TC07	45	NSN14T13	TP19DAT-6.P2
Pulsar	01	-	NS3TK-11		▲	Ph/Cry	PH1B	45	NSN14T11	TP13DAT-15.P2
Serena	96	98	NS2TK-1*			Ph	PH00	45	NSN11T2	TP05DAT-6P2
Serena	98	-	NS2TK-11		▲	Ph/Cry	PH1B	45	NSN11T11	-
Terrano II	95	98	NS2TK-1*			Ph	PH00	45	NSN11T2	TP05DAT-6P2
Terrano II	99	01	NS2TK-11		▲	Ph/Cry	PH1B	45	NSN11T11	-
Terrano II	02	06	NS2TK-13	■		Tex/Cry	TC07	45	NSN11T13	-
Vanette	96	99	NS2TK-1*			Ph	PH00	45	NSN11T2	TP05DAT-6P2
Vanette	99	-	NS2TK-11		▲	Ph/Cry	PH1B	45	NSN11T11	-
X-Trail	01	07	NS3TK-13	■		Tex/Cry	TC07	45	NSN14T13	TP19DAT-6.P2
OPEL (D)										
Agila	04	-	VX5TK-12			Ph/Cry	PH1A	48	HU100T2	-
Astra	95	98	VX2TK-1*			Ph	PH00	47	YM28T2	TP05OP-DP
Astra	95	98	VX1TK-1*			Ph	PH00	47	HU46T2	TP05OP-SP
Astra	99	01	VX1TK-9			Ph/Cry	PH1A	47	HU46T9	-
Astra	99	01	VX1TK-1*			Ph/Cry	PH1A	47	HU46T2	TP05OP-SP
Astra	99	01	VX2TK-1*			Ph/Cry	PH1A	47	YM28T2	TP05OP-DP
Astra	99	01	VX2TK-9			Ph/Cry	PH1A	47	-	-
Astra	01	04	VX1TK-12			Ph/Cry	PH1A	47	HU49T12	-
Astra	01	04	VX1TK-1*			Ph/Cry	PH1A	47	HU46T2	TP05OP-SP
Calibra	95	98	VX3TK-5			Ph	PH00	48	YM27T2	TP01OP-WYP
Calibra	95	98	VX4TK-5			Ph	PH00	48	HU43T2	TP01OP-WHP
Combo	98	02	VX1TK-1*			Ph	PH00	47	HU46T2	TP05OP-SP
Combo	02	04	VX1TK-1*			Ph/Cry	PH1A	47	HU46T2	TP05OP-SP
Combo	02	04	VX1TK-12			Ph/Cry	PH1A	47	HU49T12	-
Combo	04	-	VX5TK-12			Ph/Cry	PH1A	48	HU100T2	-
Corsa	95	98	VX2TK-1*			Ph	PH00	47	YM28T2	TP05OP-DP
Corsa	95	98	VX1TK-1*			Ph	PH00	47	HU46T2	TP05OP-SP
Corsa	99	00	VX2TK-1*			Ph/Cry	PH1A	47	YM28T2	TP05OP-DP
Corsa	99	00	VX1TK-9			Ph/Cry	PH1A	47	HU46T9	-

MODEL	YEAR		KEYLINE REFERENCE	KEYLINE MICRO SERIES			TRANS. TYPE	ID	PAGE	CROSS REFERENCE OF SUBSTITUTE (WHERE AVAILABLE)	
				T	P	M					
OPEL (D)											
Corsa	99	00	VX1TK-1*				Ph/Cry	PH1A	47	HU46T2	TP05OP-SP
Corsa	99	00	VX2TK-9				Ph/Cry	PH1A	47	-	-
Corsa	00	04	VX1TK-12				Ph/Cry	PH1A	47	HU49T12	-
Corsa	00	04	VX1TK-1*				Ph/Cry	PH1A	47	HU46T2	TP05OP-SP
Corsa	04	-	VX5TK-12				Ph/Cry	PH1A	48	HU100T2	-
Meriva	02	04	VX1TK-12				Ph/Cry	PH1A	47	HU49T12	-
Meriva	02	04	VX1TK-1*				Ph/Cry	PH1A	47	HU46T2	TP05OP-SP
Meriva	04	10	VX5TK-12				Ph/Cry	PH1A	48	HU100T2	-
Omega	95	99	VX3TK-5				Ph	PH00	48	YM27T2	TP01OP-WYP
Omega	95	99	VX4TK-5				Ph	PH00	48	HU43T2	TP01OP-WHP
Omega	99	00	VX1TK-1*				Ph/Cry	PH1A	47	HU46T2	TP05OP-SP
Omega	99	00	VX2TK-1*				Ph/Cry	PH1A	47	YM28T2	TP05OP-DP
Omega	99	00	VX2TK-9				Ph/Cry	PH1A	47	-	-
Omega	99	00	VX1TK-9				Ph/Cry	PH1A	47	HU46T9	-
Sintra	97	-	VX4TK-5				Ph	PH00	48	HU43T2	TP01OP-WHP
Speedster	01	-	VX1TK-12				Ph/Cry	PH1A	47	HU49T12	-
Speedster	01	-	VX1TK-1*				Ph/Cry	PH1A	47	HU46T2	TP05OP-SP
Tigra	95	97	VX1TK-1*				Ph	PH00	47	HU46T2	TP05OP-SP
Tigra	95	97	VX2TK-1*				Ph	PH00	47	YM28T2	TP05OP-DP
Tigra	98	01	VX1TK-9				Ph/Cry	PH1A	47	HU46T9	-
Tigra	98	01	VX2TK-9				Ph/Cry	PH1A	47	-	-
Tigra	98	01	VX2TK-1*				Ph/Cry	PH1A	47	YM28T2	TP05OP-DP
Tigra	98	01	VX1TK-1*				Ph/Cry	PH1A	47	HU46T2	TP05OP-SP
Tigra	01	04	VX1TK-1*				Ph/Cry	PH1A	47	HU46T2	TP05OP-SP
Tigra	01	04	VX1TK-12				Ph/Cry	PH1A	47	HU49T12	-
Tigra	04	-	VX5TK-12				Ph/Cry	PH1A	48	HU100T2	-
Vectra	95	98	VX4TK-5				Ph	PH00	48	HU43T2	TP01OP-WHP
Vectra	95	98	VX3TK-5				Ph	PH00	48	YM27T2	TP01OP-WYP
Vectra	98	02	VX4TK-12				Ph/Cry	PH1A	48	HU43T9	TP09OP-WHP
Zafira	99	01	VX4TK-12				Ph/Cry	PH1A	48	HU43T9	TP09OP-WHP
Zafira	01	05	VX1TK-1*				Ph/Cry	PH1A	47	HU46T2	TP05OP-SP
Zafira	01	05	VX1TK-12				Ph/Cry	PH1A	47	HU49T12	-
PEUGEOT (F)											
106	97	00	PG30LTK-1*				Ph	PH00	46	NE72AT5	TP05NE-38.P2
306	97	-	PG30LTK-1*				Ph	PH00	46	NE72AT5	TP05NE-38.P2
406	97	99	PG31TK-1*				Ph	PH00	46	NE78T5	TP05NE-51.P2
607	01	04	PG31TK-1*			●	Meg/Cry	MG10	46	NE78T5	TP05NE-51.P2
PONTIAC (USA)											
G3	10	-	DAE48STK-1*			●	Meg/Cry	MG10	43	DWO4RT5	TP05DAE-3D.P1
Wave	04	06	DAE48STK-1*			●	Meg/Cry	MG10	43	DWO4RT5	TP05DAE-3D.P1
ROVER (GB)											
400	97	-	RV3TK-1*				Ph	PH00	46	NE77RT2	TP05NE-35.P3
600	97	-	RV3TK-1*				Ph	PH00	46	NE77RT2	TP05NE-35.P3
618	96	-	RV3TK-1*				Ph	PH00	46	NE77RT2	TP05NE-35.P3
620	96	-	RV3TK-1*				Ph	PH00	46	NE77RT2	TP05NE-35.P3
800	97	98	RV3TK-1*				Ph	PH00	46	NE77RT2	TP05NE-35.P3
SEAT (E)											
Cordoba	95	98	V35TK-1*				Ph	PH00	46	HU49T5	TP01VO-2P
Ibiza	95	98	V35TK-1*				Ph	PH00	46	HU49T5	TP01VO-2P

MODEL	YEAR		KEYLINE REFERENCE	KEYLINE MICRO SERIES			TRANS. TYPE	ID	PAGE	CROSS REFERENCE OF SUBSTITUTE (WHERE AVAILABLE)	
				T	P	M					
SEAT (E)											
Inca	96	98	V35TK-1*				Ph	PH00	46	HU49T5	TP01VO-2P
Marbella	95	98	V35TK-1*				Temic	TM10	46	HU49T5	TP01VO-2P
Toledo	95	98	V35TK-1*				Ph	PH00	46	HU49T5	TP01VO-2P
ŠKODA (CZ)											
Fabia	00	04	AD66TK-8			●	Meg/Cry	MG10	42	HU66AT6	TP05HU-HAA.P
Fabia	05	10	AD66TK-8			●	Meg/Cry	MG10	42	HU66AT6	TP05HU-HAA.P
Fabia	11	-	AD66TK-8			●	Meg/Cry	MG10	42	HU66AT6	TP05HU-HAA.P
Felicia	97	98	SK21STK-1*				Ph	PH00	46	SK22RT1	-
Felicia	98	99	AD66TK-1*				Ph	PH00	42	HU66AT5	TP05HU-HAA.P
Felicia	99	-	AD66TK-8			●	Meg/Cry	MG10	42	HU66AT6	TP05HU-HAA.P
Octavia	97	00	AD66TK-1*			●	Meg	MG00	42	HU66AT5	TP05HU-HAA.P
Octavia	01	-	AD66TK-8			●	Meg/Cry	MG10	42	HU66AT6	TP05HU-HAA.P
Pick-up	97	98	SK21STK-1*				Ph	PH00	46	SK22RT1	-
Pick-up	99	-	AD66TK-1*				Ph	PH00	42	HU66AT5	TP05HU-HAA.P
Roomster	06	-	AD66TK-8			●	Meg/Cry	MG10	42	HU66AT6	TP05HU-HAA.P
Roomster Scout	07	-	AD66TK-8			●	Meg/Cry	MG10	42	HU66AT6	TP05HU-HAA.P
Super B	02	-	AD66TK-8			●	Meg/Cry	MG10	42	HU66AT6	TP05HU-HAA.P
Yeti	09	-	AD66TK-8			●	Meg/Cry	MG10	42	HU66AT6	TP05HU-HAA.P
SUBARU (J)											
Impreza	96	00	NS2TK-1*				Ph	PH00	45	NSN11T2	TP05DAT-6P2
Legacy	96	98	NS2TK-1*				Ph	PH00	45	NSN11T2	TP05DAT-6P2
Outback	96	98	NS2TK-1*				Ph	PH00	45	NSN11T2	TP05DAT-6P2
TOYOTA (J)											
Paseo	96	99	TR12TK-5				Ph	PH00	46	TOY42AT5	-
Previa	96	99	TR12TK-5				Ph	PH00	46	TOY42AT5	-
TOYOTA JAPAN											
Alphard	03	-	TR12TK-5	■			Tex	TX00	46	TOY42AT5	-
Estima	97	01	TR12TK-5	■			Tex	TX00	46	TOY42AT5	-
VOLKSWAGEN (D)											
Caddy	95	98	V35TK-1*				Ph	PH00	46	HU49T5	TP01VO-2P
Caddy	98	00	V35TK-10		▲		Ph/Cry	PH1C	46	HU49T10	TP10VO-2P
Caddy	04	-	V35STK-8			●	Meg/Cry	MG10	47	HU49RT6	-
Golf	95	97	V35TK-1*				Ph	PH00	46	HU49T5	TP01VO-2P
LT	00	-	YS15TK-1*				Temic	TM10	48	YM15T5	TP04ME-HMP1
Passat	95	96	V35TK-1*				Ph	PH00	46	HU49T5	TP01VO-2P
Polo	95	98	V35TK-1*				Ph	PH00	46	HU49T5	TP01VO-2P
Saveiro	99	-	V35STK-8			●	Meg/Cry	MG10	47	HU49RT6	-
Transporter	95	98	V35TK-1*				Ph	PH00	46	HU49T5	TP01VO-2P
Transporter	98	00	V35TK-10		▲		Ph/Cry	PH1C	46	HU49T10	TP10VO-2P
Vento	95	-	V35TK-1*				Ph	PH00	46	HU49T5	TP01VO-2P
VOLVO (S)											
850	96	-	VL17TK-1*				Ph	PH00	47	NE66T2	-
940	95	-	VL10TK-1*				Ph	PH00	47	NE51T2	-
C 70	97	98	VL17TK-1*				Ph	PH00	47	NE66T2	-
Polar	96	-	VL10TK-1*				Ph	PH00	47	NE51T2	-
S 40	96	04	VL15TK-1*				Ph	PH00	47	HU56RAT2	TP05HU-DH.P1
S 60	00	-	VL17TK-1*			●	Meg/Cry	MG10	47	NE66T2	-
S 70	96	98	VL17TK-1*				Ph	PH00	47	NE66T2	-
V 40	96	98	VL15TK-1*				Ph	PH00	47	HU56RAT2	TP05HU-DH.P1

MODEL	YEAR		KEYLINE REFERENCE	KEYLINE MICRO SERIES			TRANS. TYPE	ID	PAGE	CROSS REFERENCE OF SUBSTITUTE (WHERE AVAILABLE)	
				T	P	M					
VOLVO (S)											
V 70	96	98	VL17TK-1*				Ph	PH00	47	NE66T2	-
V 70	00	07	VL17TK-1*			●	Meg/Cry	MG10	47	NE66T2	-
XC70	03	-	VL17TK-1*			●	Meg/Cry	MG10	47	NE66T2	-
XC90	03	-	VL17TK-1*			●	Meg/Cry	MG10	47	NE66T2	-

* Discontinued transponder: Keyline doesn't supply this code anymore.
 ** Discontinued product: Keyline doesn't supply this article anymore.

* Transponder discontinuato: Keyline non fornisce più questo codice.
 ** Prodotto discontinuato: Keyline non fornisce più questo articolo.

Copyright by



Innovators by design | Since 1770

A BIANCHI 1770 GROUP COMPANY

Le illustrazioni e i dati tecnici dei prodotti contenuti nel catalogo debbono considerarsi indicativi.

Keyline si riserva di poter modificare i prodotti illustrati senza compromettere la loro funzionalità ed intercambiabilità al fine di migliorare la qualità del prodotto.

Tutti i disegni e le fotografie sono di proprietà di Keyline, ogni riproduzione anche parziale, senza autorizzazione scritta della Keyline è vietata secondo termini di legge.

Per qualsiasi controversia sono competenti gli Uffici Giudiziari dove ha sede l'Azienda, con espressa esclusione di qualsiasi altro foro.

All information and illustrations in this catalogue are for guidance only.

Keyline reserves the right to alter the illustrated products without compromising their functionality and interchangeability in order to improve the quality of the product itself.

The contents of this catalogue are fully protected by copyright and may not be copied or reproduced in any form without written permission from Keyline.

Any infringements will be dealt with under Italian law.

Die Abbildungen und technischen Daten des Katalogs sind nur zur Information.

Keyline behält sich vor, etwaige Änderungen am Produkt vorzunehmen ohne der Zweckmaessigkeit und Auswechselbarkeit zu gefaehrden um zur Verbesserung des Produkt.

Alle Zeichnungen und Fotos sind Besitz der Firma Keyline, jede Reproduktion, auch teilweise, ist ohne schriftliche Erlaubnis der Firma Keyline gesetzlich untersagt.

Im Falle von Streitfragen ist der Gerichtshof des Firmensitzes zuständig; jeder andere Gerichtshof ist ausgeschlossen.

Les illustrations et les caractéristiques techniques des produits présentés dans ce catalogue sont données à titre indicatif.

Keyline se réserve le droit d'apporter toutes les modifications des produits illustrés sans compromettre leur caractère fonctionnel et interchangeabilité pour améliorer la qualité du produit.

Tous les dessins et photos sont propriété Keyline et toute reproduction, même partielle, sans l'autorisation écrite préalable de Keyline est interdite conformément aux prescriptions légales.

Tout litige est du ressort exclusif des Tribunaux de la circonscription où se trouve le Siège de la Société.

Las ilustraciones y los datos técnicos de los productos en este catálogo son indicativos.

Keyline se reserva el derecho de modificar los productos ilustrados sin comprometer la funcionalidad e intercambiabilidad para mejorar la calidad del producto.

Todos los dibujos y las fotografías pertenecen a la Keyline; se prohíbe toda reproducción aunque parcial, sin autorización por escrito de la Keyline.

En caso de disputas la competencia es de las autoridades judiciales donde está domiciliada la firma, excluyendo cualquier otro fuero.

To find the distributor closest to your company,
please send a request to:



Keyline

Keyline S.p.A.
Via Camillo Bianchi, 2 - P.O. Box 251
31015 Conegliano (TV) Italy
T +39 0438 202 511
F +39 0438 202 520
info@keyline.it
www.keyline.it



Bianchi 1770 Group Companies distributing Keyline products

Keyline USA

Bianchi USA, Inc.
31336 Industrial Pkwy - Suite 3
North Olmsted, Ohio 44070, USA
T +1 440 716 8006
F +1 216 803 0202
TF +1 800 891 2118
info@keyline-usa.com
www.keyline-usa.com

Keyline Italia

Keyline Italia S.r.l.
Via Zoe Fontana, 220 - Ed. C
Tecnocittà
00131 Roma, Italy
T +39 06 4122 9822
F +39 06 4120 0981
info@keyline-italia.it
www.keyline-italia.it

Keyline Shanghai

Bianchi 1770 Hardware Technology (Shanghai) Co. Ltd
比安奇五金技术（上海）有限公司
中国上海市虹口区黄浦路99号
上海滩国际大厦1505室
Room 1505, Shanghai Bund International Tower
No.99 Huangpu Road, Hong Kou District 200080
Shanghai P.R. China
T +86 021 5031 0980
F +86 021 5031 0981
info@keyline-shanghai.com
www.keyline-shanghai.com

Keyline Germany

Keyline GmbH
Uhlandstraße 31b
42549 Velbert, Germany
T +49 (0) 2051 807 4444
F +49 (0) 2051 606 9922
info@keyline-germany.de
www.keyline-germany.de

Bianchi 1770 Group Representative Offices coordinating onsite distributors

Keyline UK

18 Beeston Court - Stuart Road
Manor Park - Runcorn - Cheshire
WA7 1SS - UK
T +44 (0) 1928 571 167
F +44 (0) 1928 579 595
info@keyline-uk.co.uk
www.keyline-uk.co.uk

Keyline Japan

〒532-0011
大阪府大阪市淀川区西中島4-7-20
日宝新大阪第1ビル4階1号
Room 4F-1 Nippo Shin-Osaka Daiich Building
4-7-20 Nishinakajima, Yodogawa-ku Osaka City
Osaka 532-0011, Japan
T +81 6 4805 6969
F +81 6 4805 6900
info@keyline-japan.jp
www.keyline-japan.jp



ISO TS 16949 CERTIFIED COMPANY -
IATF CERTIFICATE N.0248044

